

**ORDINANCE NO. 184371**

An ordinance amending the Pacific Palisades Commercial Village and Neighborhoods Specific Plan to add new definitions and create a Commercial Village Subarea A with separate sign, alcohol and streetscape standards.

**THE PEOPLE OF THE CITY OF LOS ANGELES  
DO ORDAIN AS FOLLOWS:**

Section 1. The Table of Contents of the Pacific Palisades Commercial Village and Neighborhoods Specific Plan (Specific Plan) is amended in part to read as follows:

**TABLE OF CONTENTS**

Specific Plan Boundary Map

Section 1. Establishment of the Pacific Palisades Commercial Village and Neighborhoods Specific Plan

Section 2. Purposes

Section 3. Relationship to Other Provisions of the Municipal Code

Section 4. Definitions

Section 5. Prohibitions and Exceptions

Section 6. Land Use

Section 7. Height

Section 8. Floor Area Ratio

Section 9. Setbacks

Section 10. Parking

Section 11. Alcohol Consumption Regulations

Section 12. Landscape Standards and Urban Design Features

Section 13. Sign Standards

Section 14. Design Review and Standards

Section 15. Severability

Appendix A. Streetscape Design

Appendix B. Master Sign Program

Sec. 2. Map 2 of the Specific Plan is amended to create a Commercial Village Subarea A and B as shown in the attached Map 2.

Sec. 3. Paragraph J of Section 2 of the Specific Plan is deleted in its entirety.

Sec. 4. Paragraph B of Section 3 of the Specific Plan is amended to read as follows:

- B. Wherever this Specific Plan contains regulations which conflict with regulations contained in LAMC Chapter 1, the Specific Plan shall prevail and supersede the applicable provisions of that Code, including those regulations contained in the Mini-mall regulation, Ordinance No. 164,201; the Commercial Corner regulations, Ordinance No. 175,223; related sections of the LAMC for Alcohol Beverage Sales; and the Site Plan Review regulations, Ordinance No. 164,951. Procedures for the granting of exceptions to the requirements of this Specific Plan are established in LAMC Section 11.5.7. In approving an exception to this Specific Plan pursuant to Section 11.5.7, the City Planning Commission and the City Council on appeal may simultaneously approve any conditional use under their jurisdiction. Only one fee shall be required for joint applications.

Sec. 5. Section 4 of the Specific Plan is amended to add the following definitions in proper alphabetical order:

**Architectural Roof Features:** Unique details and architectural components above the parapet or building's fascia, such as cupolas, dormers, towers, louvered vents, and mansard and pitched roofs.

**Height:** The height of all building facades is limited to 30 feet and shall be measured from adjacent sidewalk to the top of the parapet or roof fascia at the building perimeter. Only in Commercial Village Subarea A, the tallest point of architectural roof features of all buildings is limited to 34 feet, as measured from the adjacent sidewalk grade.

**Marquee Sign:** A sign that is located on a marquee or a permanent roof structure attached to and supported by the building projecting over public property.

**Public Access Way:** Any public street, public right-of-way, pedestrian paseo, or vehicular alley drive that provides pedestrian access open to the public.

Sec. 6. Paragraph A of Section 7 of the Specific Plan is amended to read as follows:

- A. Notwithstanding LAMC Section 12.21.1 B 3, no Project located in whole or in part within the Specific Plan Area shall exceed two stories or 30 feet in height. As defined in Section 4, in Commercial Village Subarea A, buildings with architectural roof features are limited to 34 feet in height.

Sec. 7. Subsection 3 of Paragraph B of Section 10 of the Specific Plan is amended to read as follows:

- 3. For retail, community rooms, and service commercial uses, one parking space for each 300 square feet of floor area.

Sec. 8. A new Subsection 4 of Paragraph D of Section 10 is added to the Specific Plan to read as follows:

- 4. In Commercial Village Subarea A, bicycle parking shall be pursuant to LAMC Section 12.21 A 16.

Sec. 9. Section 11 of the Specific Plan is amended in its entirety to read as follows:

**Section 11. ALCOHOL CONSUMPTION REGULATIONS—COMMERCIAL VILLAGE  
SUBAREA A**

The sale and service of alcoholic beverages for on-site and off-site consumption shall be permitted within Commercial Village Subarea A as provided below. Entities that sell and serve alcoholic beverages for on-site and off-site consumption shall obtain approvals from other jurisdictions, as required, including licenses or permits from the State Department of Alcoholic Beverage Control (ABC). A maximum total of eight (8) Alcohol Use Approvals (including on-site and off-site) shall be permitted.

- A. **Alcohol Use Approvals for Alcoholic Beverage Sales for On-Site Consumption.** Except as set forth below and notwithstanding Chapter 1 of the LAMC, the application for the sale and service of alcoholic beverages for on-site consumption shall be processed pursuant to the procedures in LAMC Section 12.24 M under the authority of the Director of Planning, subject to the following:

1. **Number of Establishments.** A maximum total of six (6) on-site establishments are permitted within Commercial Village Subarea A after the effective date of this Specific Plan, as follows:
  - a. One (1) approval for the on-site sale and consumption of a full line of alcoholic beverages within a theatre;
  - b. Five (5) approvals for the on-site sale and consumption of a full line of alcoholic beverages in conjunction with restaurants;
  - c. The number of establishments listed above may be adjusted within each category, provided that the total number of licensed premises does not exceed 6, and subject to a Plan Approval pursuant to LAMC Section 12.24 M.
2. **Application for Permit.** To apply for an Alcohol Use Approval, an applicant shall file an application with the Department of City Planning pursuant to LAMC Section 12.24 B.
3. **Conditions.** The Director of Planning, through the Alcohol Use Approval process, shall review applications for compliance with LAMC Section 12.24 F.
4. **Findings.** Findings shall be made pursuant to LAMC Section 12.24 W.1(a).
5. **Public Hearing.** At the discretion of the Director of Planning a public hearing may be held on an On-Site Alcohol Use Approval application if the application is likely to be controversial. If a public hearing is conducted, procedures shall be followed pursuant to LAMC Section 12.24 D.
6. **Time to Act.** Time to act for Alcohol Use Approvals shall follow procedures set forth in LAMC Section 12.24.G—H.
7. **Appeals.** Any appeal filed from a Director of Planning's Determination shall be processed pursuant to the provisions and procedures set forth in LAMC Section 12.24 M.



8. **Discontinuance of Use.** Notwithstanding LAMC Section 12.24 Q to the contrary, the 6 Alcohol Use Approvals permitted by this Specific Plan shall continue through the life of the Specific Plan. If an Alcohol Use Approval for a given establishment is abandoned, or is discontinued for a continuous period of one year, it may not be re-established unless authorized in accordance with the procedure prescribed in Section 11.A. of the Specific Plan.
9. **Revocation.** If the conditions of this Subsection have not been complied with, the City may give notice to the property owner or lessee of the real property affected to appear at a time and place fixed by the City and show cause why the use permitted by this Subsection should not be modified, discontinued or revoked. These proceedings shall be in accordance with LAMC Section 12.24 Z.

B. **Alcohol Use Approvals for Alcoholic Beverage Sales for Off-Site Consumption.** All off-sale alcohol uses, including renewals of existing conditional uses and the establishment of new conditional uses in the Commercial Village Subarea A, shall be subject to review and decision by a Director of Planning.

1. **Number of Establishments.** A maximum total of two (2) Alcohol Use Approvals shall be allowed for sale of a full-line of alcoholic beverages for off-site consumption within Commercial Village Subarea A, after the effective date of this Specific Plan, as follows:
  - a. One (1) approval for the off-site consumption of a full line of alcoholic beverages in conjunction with a specialty retail use;
  - b. One (1) approval for the off-site consumption of a full line of alcoholic beverages in conjunction with market.
  - c. The number of establishments listed above may be adjusted within each category, provided that the total number of licensed premises does not exceed 2, and subject to a Plan Approval pursuant to LAMC Section 12.24 M.

2. **Application for Permit.** To apply for an Alcohol Use Approval an applicant shall file an application with the Department of City Planning pursuant to LAMC Section 12.24 B.
3. **Conditions.** The Director of Planning, through the Alcohol Use Approval process, shall review applications for compliance with LAMC Section 12.24 F.
4. **Findings.** Findings shall be made pursuant to LAMC Section 12.24 W.1(a).
5. **Public Hearing.** At the discretion of the Director of Planning a public hearing may be held on an Alcohol Use Approval application involving an establishment seeking off-site consumption if the application is likely to be controversial. If a public hearing is conducted, procedures shall be followed pursuant to LAMC Section 12.24 D.
6. **Time to Act.** Time to act for Alcohol Use Approvals shall follow procedures set forth in LAMC Section 12.24 G—H.
7. **Appeals.** Any appeal filed from a Director of Planning's Determination shall be processed pursuant to the provisions and procedures set forth in LAMC Section 12.24 M.
8. **Discontinuance of Use.** Notwithstanding LAMC Section 12.24 Q to the contrary, the 2 Alcohol Use Approvals permitted by this Specific Plan shall continue through the life of the Specific Plan. If an Alcohol Use Approval for a given establishment is abandoned, or is discontinued for a continuous period of one year, it may not be re-established unless authorized in accordance with the procedure prescribed in Section 11.A. of the Specific Plan.
9. **Revocation.** If the conditions of this Subsection have not been complied with, the City may give notice to the property owner or lessee of the real property affected to appear at a time and place fixed by the City and show cause why the use permitted by this Subsection should not be modified, discontinued or revoked. These proceedings shall be in accordance with LAMC Section 12.24 Z.

Sec. 10. A new Paragraph I is added to Section 12 of the Specific Plan to read as follows:

**I. Underground Utilities**

Where feasible, when a new building or structure is developed within the Specific Plan Area, utility connections shall be placed underground.

Sec. 11. Subsections 6 and 8 of Paragraph B of Section 13 of the Specific Plan are amended to read as follows:

- 6. With the exception of Commercial Village Subarea A, marquee signs and signs attached to awnings may not project above the marquee or awning; may not extend more than 12 inches below the marquee or awning; and shall be at least 8 feet above the sidewalk or ground. In Commercial Village Subarea A, a marquee sign may not exceed 200 square feet of sign area per face and may project outward from a building. Such sign shall not be located lower than 8 feet above grade and may not exceed 30 feet in height above the adjacent sidewalk grade.
- 8. Notwithstanding Subsections (c), (d) and (e) of LAMC Section 62.132, banners shall only be permitted if: (a) the banner is hung on a 4-foot flag pole; (b) it is attached to the front of a building or structure; and (c) there is clearance of at least 12 feet above the adjacent grade. Banners shall be a uniform size of four by two and one-half feet and may not be displayed for more than 30 days.

Sec. 12. A new Subsection 13 is added to Paragraph B of Section 13 of the Specific Plan to read as follows:

- 13. All signs located in Commercial Village Subarea A shall comply with the Master Sign Program provided in Appendix B of this Specific Plan. Signs conforming to Appendix B shall be eligible for Administrative Clearance pursuant to LAMC Section 12.32 S.4. All other signs shall be subject to LAMC Sections 11.5.7 and 16.50.

Sec. 13. Appendix A for Streetscape Design (attached to this ordinance) is added to the Specific Plan.

Sec. 14. Appendix B for a Master Sign Program (attached to this ordinance) is added to the Specific Plan.

Sec. 15. The City Clerk shall certify to the passage of this ordinance and have it published in accordance with Council policy, either in a daily newspaper circulated in the City of Los Angeles or by posting for ten days in three public places in the City of Los Angeles: one copy on the bulletin board located at the Main Street entrance to the Los Angeles City Hall; one copy on the bulletin board located at the Main Street entrance to the Los Angeles City Hall East; and one copy on the bulletin board located at the Temple Street entrance to the Los Angeles County Hall of Records.

I hereby certify that this ordinance was passed by the Council of the City of Los Angeles, at its meeting of JUN 21 2016.

HOLLY L. WOLCOTT, City Clerk

By  Deputy

Approved JUN 24 2016

 Mayor  
**ACTING**

Approved as to Form and Legality

MICHAEL N. FEUER, City Attorney

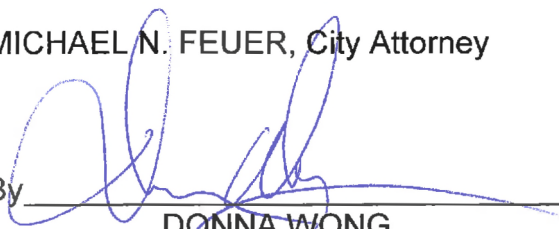
By   
DONNA WONG  
Deputy City Attorney

Date June 16, 2016

File No(s). CF 16-0627-31

Pursuant to Charter Section 559, I approve this ordinance on behalf of the City Planning Commission and recommend that it be adopted . . . . .

June 16, 2016

See attached report.

  
Vincent P. Bertoni, AICP  
Director of Planning

## DECLARATION OF POSTING ORDINANCE

I, JUAN VERANO, state as follows: I am, and was at all times hereinafter mentioned, a resident of the State of California, over the age of eighteen years, and a Deputy City Clerk of the City of Los Angeles, California.

Ordinance No.184371 – Amending the Pacific Palisades Commercial Village and Neighborhoods Specific Plan to add new definitions and create a Commercial Village Subarea A with separate sign, alcohol and streetscape standards.– a copy of which is hereto attached, was finally adopted by the Los Angeles City Council on June 21, 2016, and under the direction of said City Council and the City Clerk, pursuant to Section 251 of the Charter of the City of Los Angeles and Ordinance No. 172959, on June 28, 2016 I posted a true copy of said ordinance at each of the three public places located in the City of Los Angeles, California, as follows: 1) one copy on the bulletin board located at the Main Street entrance to the Los Angeles City Hall; 2) one copy on the bulletin board located at the Main Street entrance to the Los Angeles City Hall East; 3) one copy on the bulletin board located at the Temple Street entrance to the Los Angeles County Hall of Records.

Copies of said ordinance were posted conspicuously beginning on June 28, 2016 and will be continuously posted for ten or more days.

I declare under penalty of perjury that the foregoing is true and correct.

Signed this 28th day of June 2016 at Los Angeles, California.

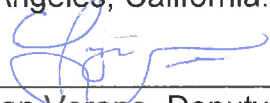
  
\_\_\_\_\_  
Juan Verano, Deputy City Clerk

Ordinance Effective Date: August 7, 2016

Council File No. 16-0627-S1

## Map 2

Pacific Palisades Commercial Village and Neighborhoods Specific Plan



LEGEND

- Commercial Village Subarea A
- Commercial Village Subarea B

Map 2

Commercial Village





**APPENDIX A**  
**Streetscape Design**

## Appendix A Streetscape Design

### INTRODUCTION

The goal of Palisades Village is to seamlessly integrate the project into the existing commercial, residential and streetscape fabric of the Palisades.

Buildings will be sited within the project to create a strong street wall along Swarthmore Avenue and Sunset Boulevard. The project will incorporate mid-block pedestrian walkways which will include pedestrian level lighting, water features, landscaping and special paving. The existing service alley running parallel to Sunset Boulevard and perpendicular to Swarthmore has been maintained to service the project and the adjacent properties.

Large sidewalk planting areas will be provided and maintained with lush, mature trees and plantings along the length of Swarthmore. Mature and healthy trees shall be maintained while unhealthy, damaged and existing street trees in poor condition will be replaced with mature specimen trees.

Drought tolerant, California native landscaping shall be utilized to limit irrigation needs and conserve water. Pedestrian promenades and plazas will incorporate permeable or porous paving materials to facilitate storm water capture and retention and to prevent runoff.

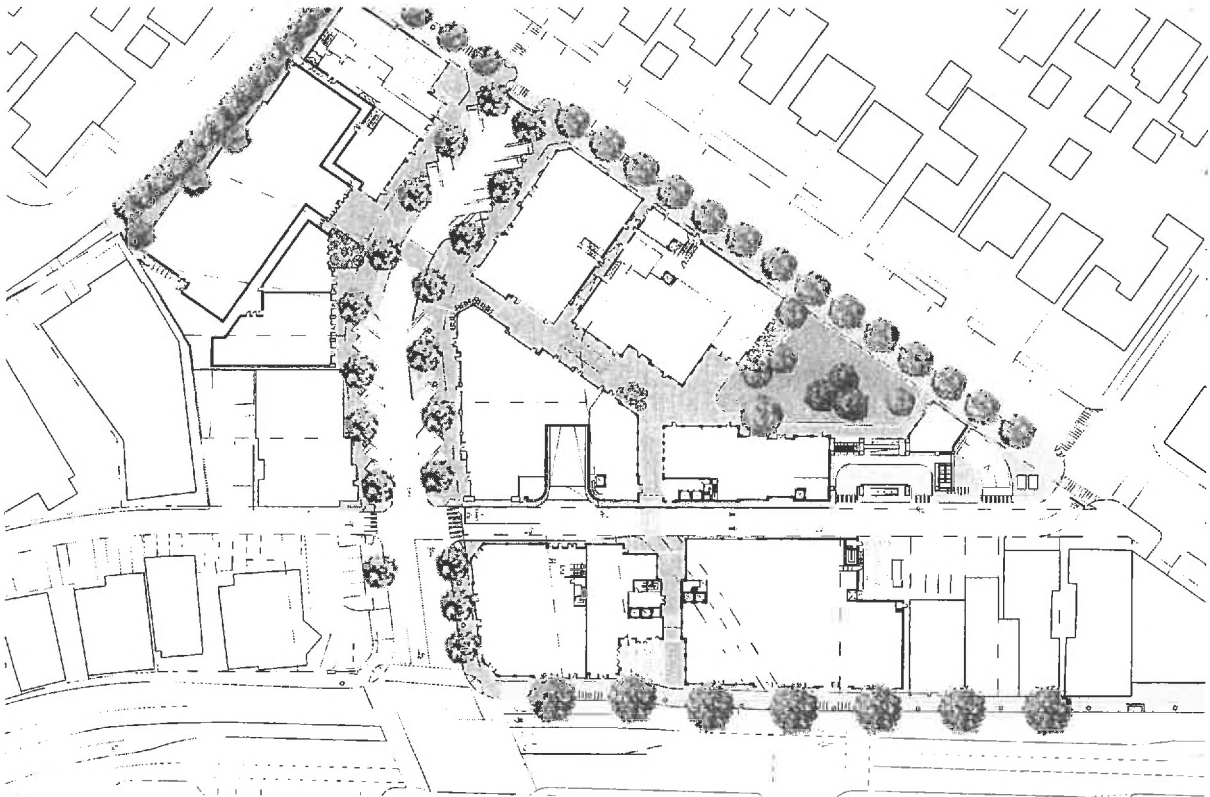
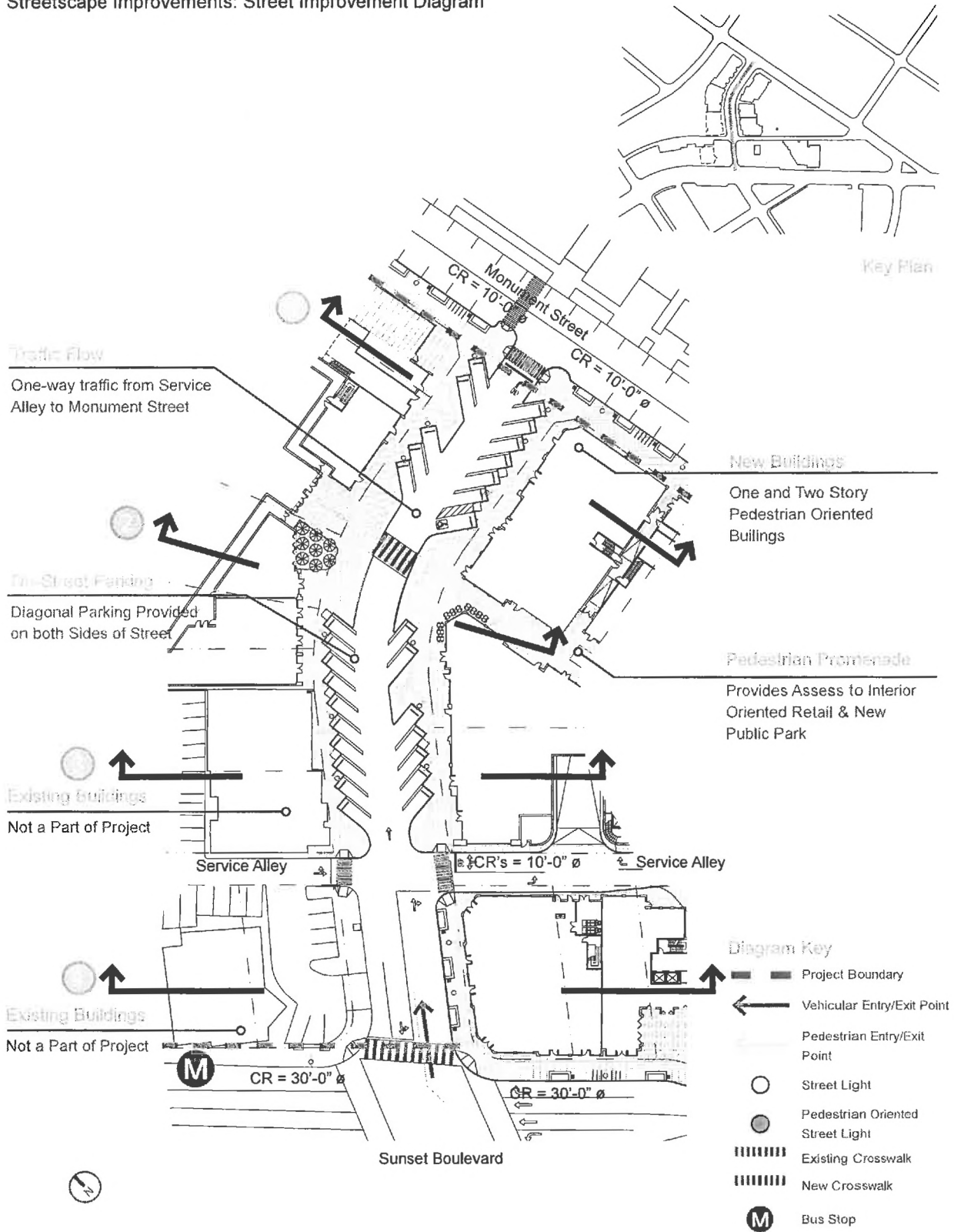

Figure A.1 - Proposed Streetscape Design



# Appendix A. Streetscape Design

## Swarthmore Avenue Streetscape Improvements: Street Improvement Diagram



Appendix A. Streetscape Design

Swarthmore Avenue  
Streetscape Improvements: Street Sections

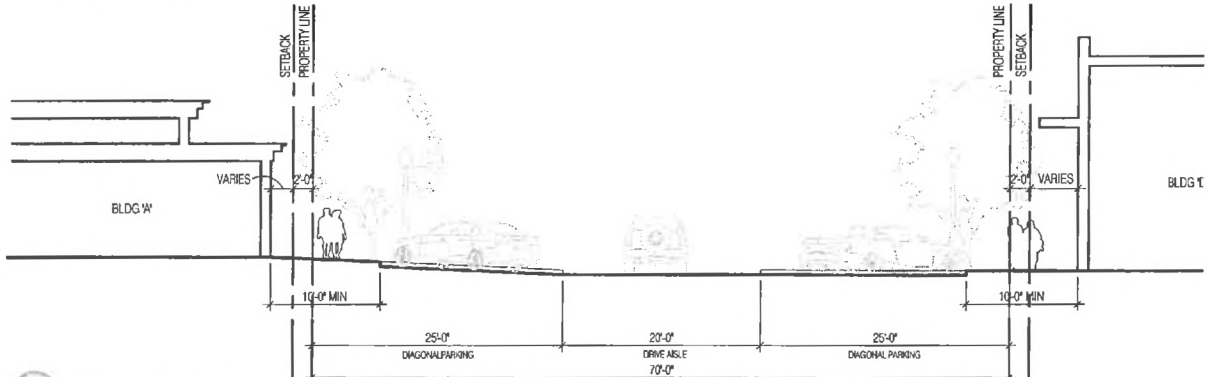

1 Swarthmore Avenue Near Intersection of Monument Street

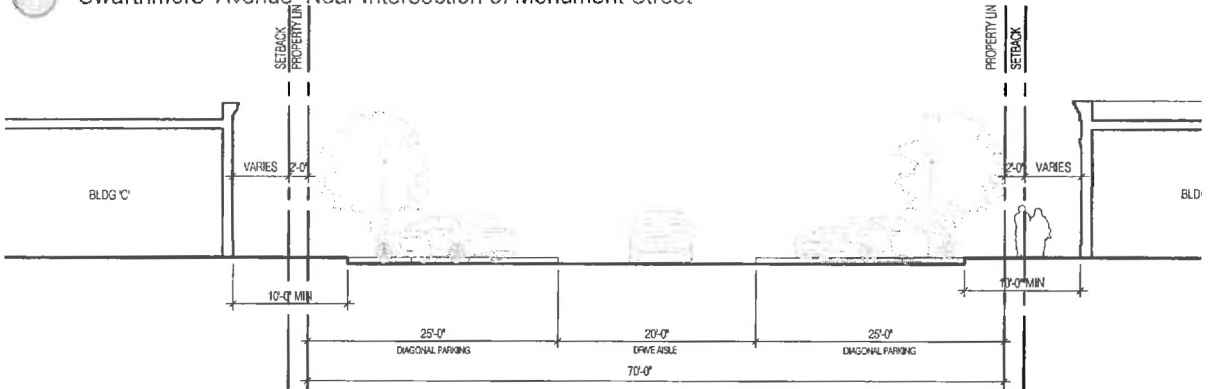

2 Swarthmore Avenue Near Pedestrian Entry

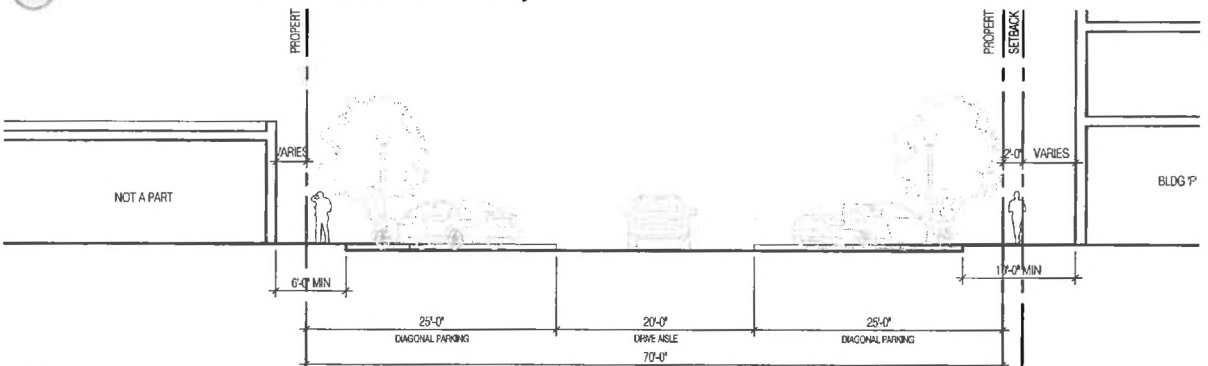

3 Swarthmore Avenue Near Intersection of Service Alley

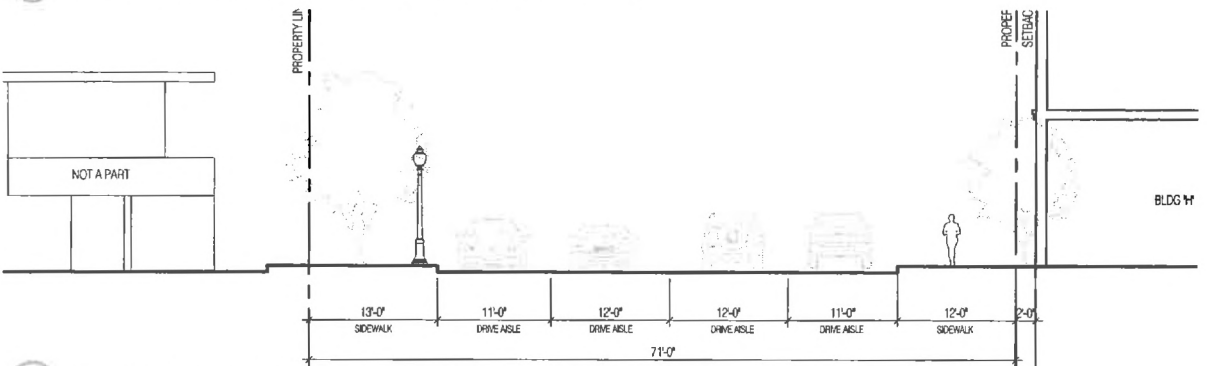

4 Swarthmore Avenue Near Intersection of Sunset Boulevard

# Appendix A. Streetscape Design

## Swarthmore Avenue Streetscape Improvements: Street Paving Plan

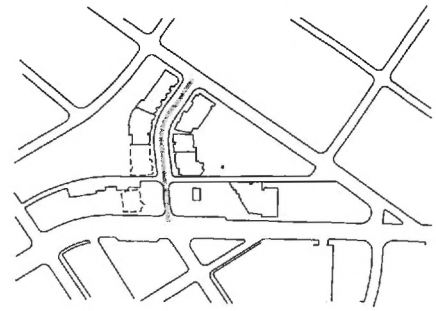

Key Plan

### Sidewalk Paving

Brick; Herringbone Pattern

### Cinema Plaza Paving

Brick Pavers

### Sidewalk Easement

Line dotted of 6 feet clear, unobstructed pedestrian route on sidewalk on Public Right of Way and private land within project property line with appropriate Easement to ensure protection of route

### On-Street Parking

Diagonal Parking Provided on both Sides of Street

### Pedestrian Lighting

Sidewalk mounted luminaire & pole

### Sidewalk Paving

Brick; Herringbone Pattern

### Sidewalk Paving

Concrete

### Sidewalk Corner

Brick Paving

### Pedestrian Lighting

Sidewalk mounted luminaire & pole

### Pedestrian Crosswalk

Brick Paving

### Street Paving

Asphalt; Concrete curb & gutter

### Sidewalk Paving

Brick; Herringbone Pattern

### Sidewalk Easement

Line dotted of 6 feet clear, unobstructed pedestrian route on sidewalk on Public Right of Way and private land within project property line with appropriate Easement to ensure protection of route

### Sidewalk Paving

Brick; Herringbone Pattern

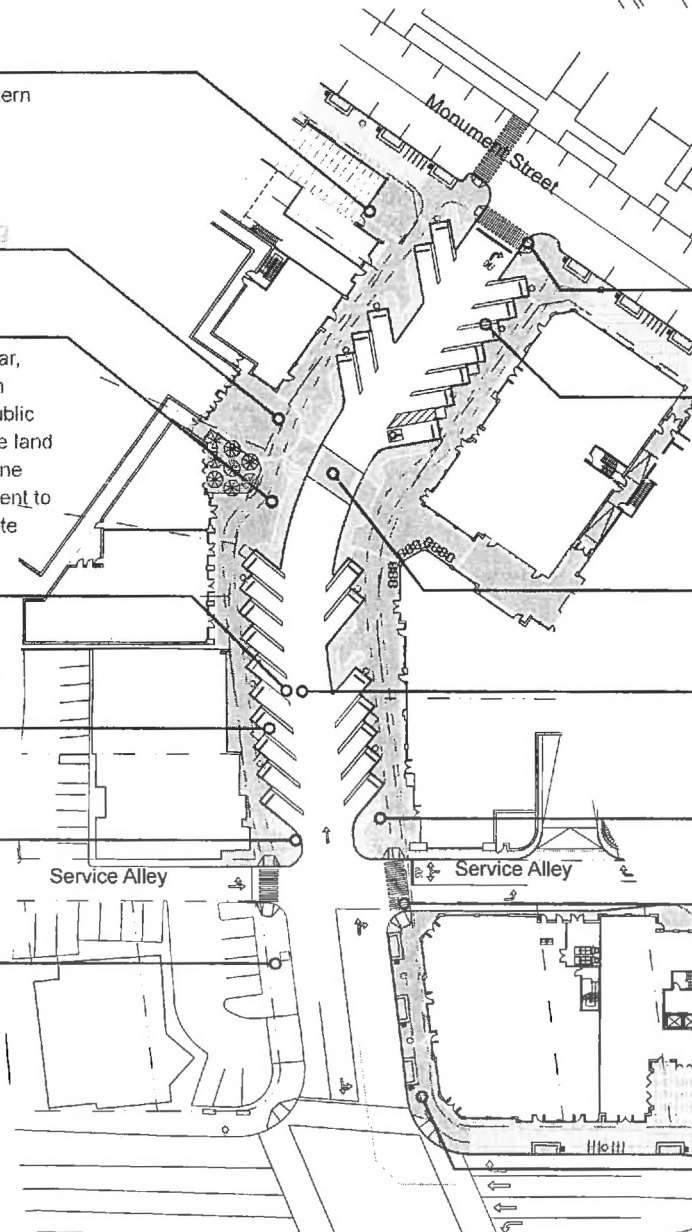

# Appendix A. Streetscape Design

## Swarthmore Avenue

### Streetscape Improvements: Street Planting Plan

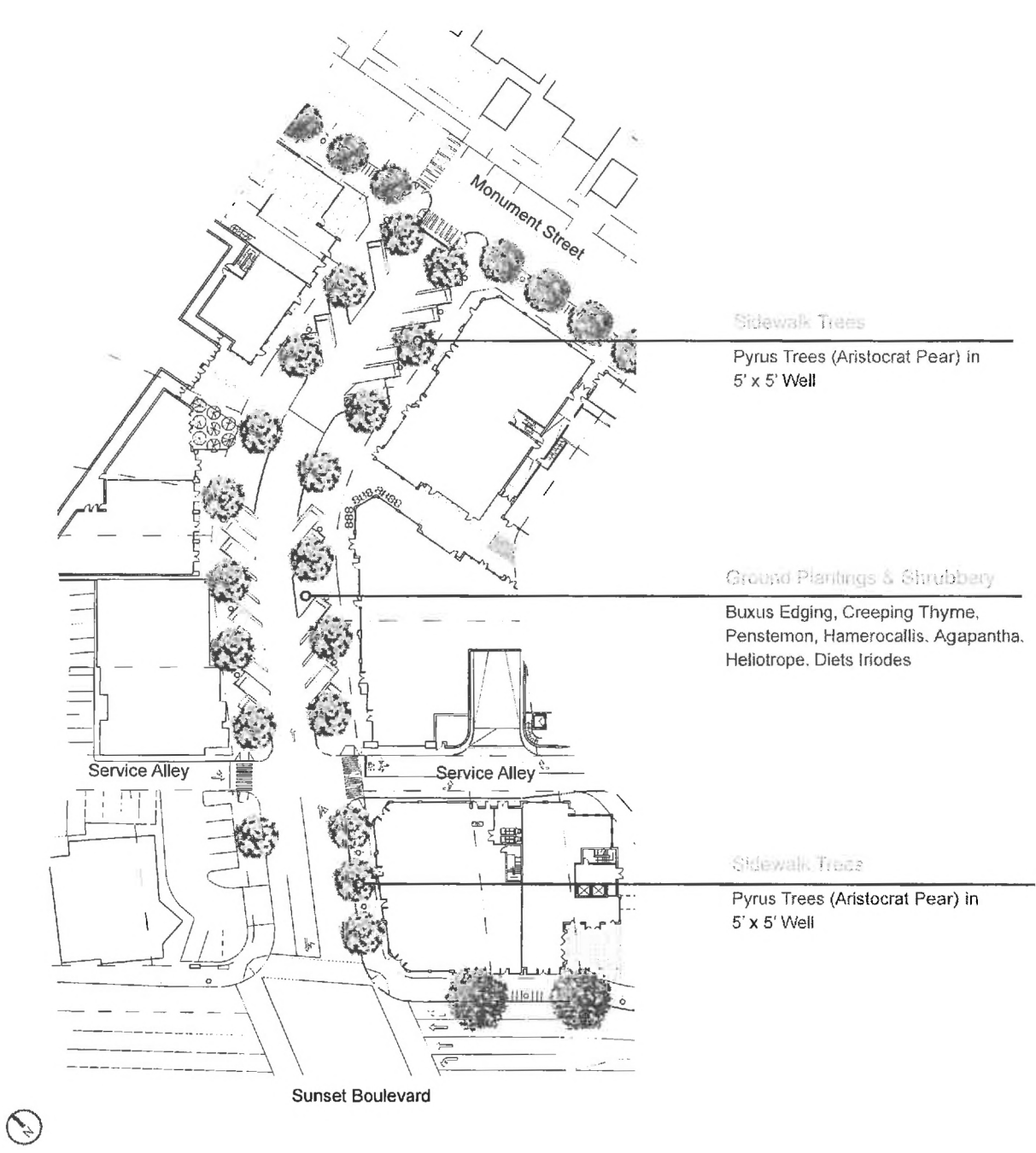

# Appendix A. Streetscape Design

## Sunset Boulevard Streetscape Improvements: Street Diagram and Paving Plan

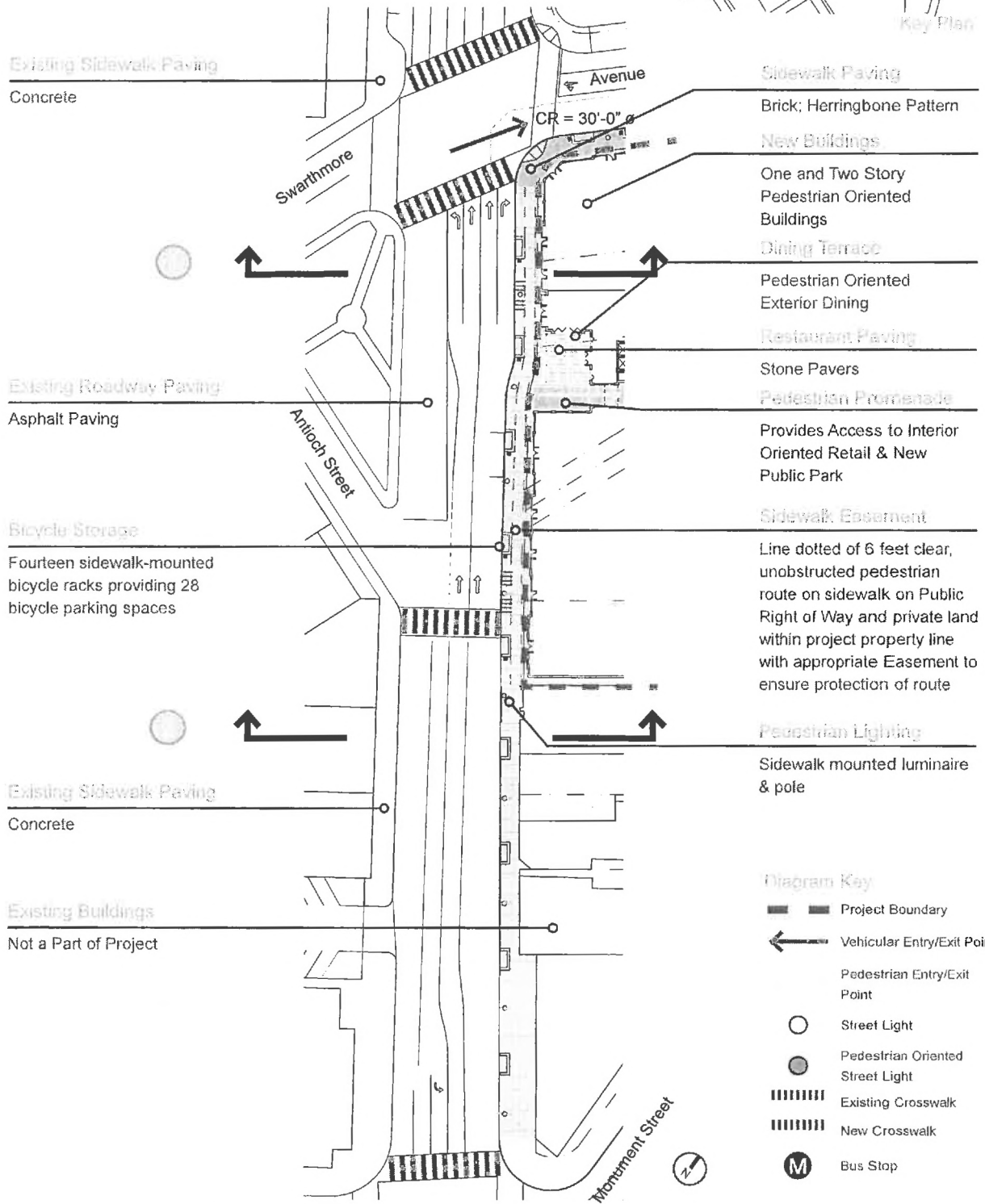
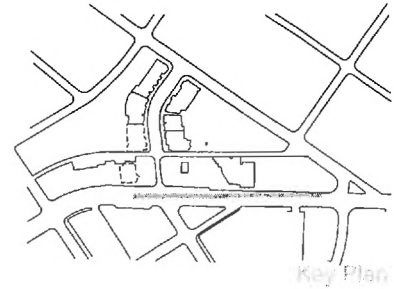

Pacific Palisades Commercial Village and Neighborhoods Specific Plan

# Appendix A. Streetscape Design

## Sunset Boulevard Streetscape Improvements: Street Sections

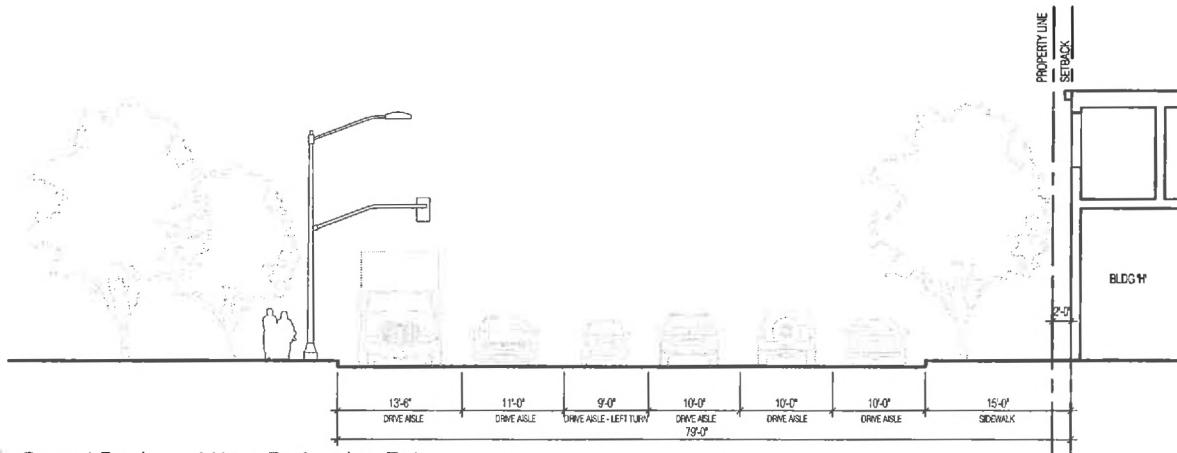

○ Sunset Boulevard Near Pedestrian Entry

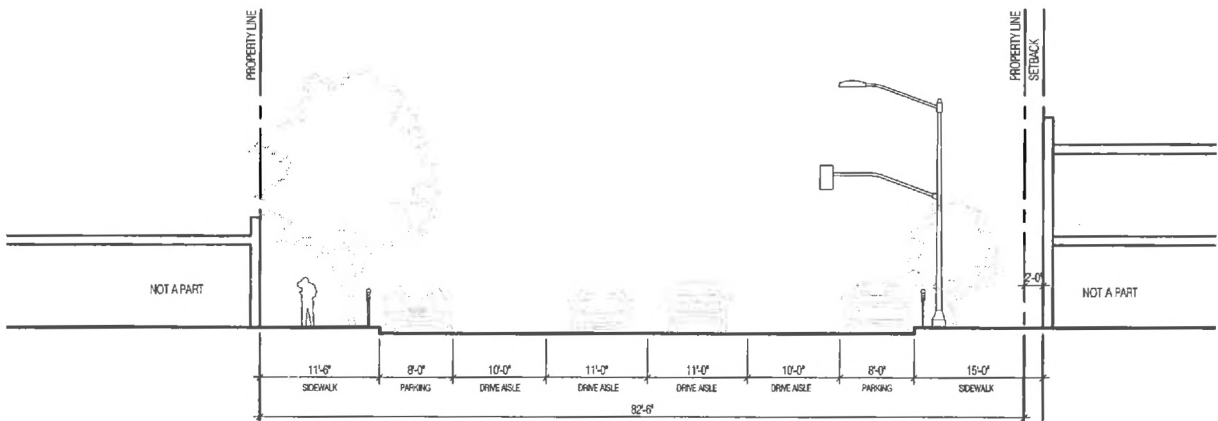

○ Sunset Boulevard Near Intersection of Service Alley



# Appendix A. Streetscape Design

## Sunset Boulevard

### Streetscape Improvements: Street Planting Plan

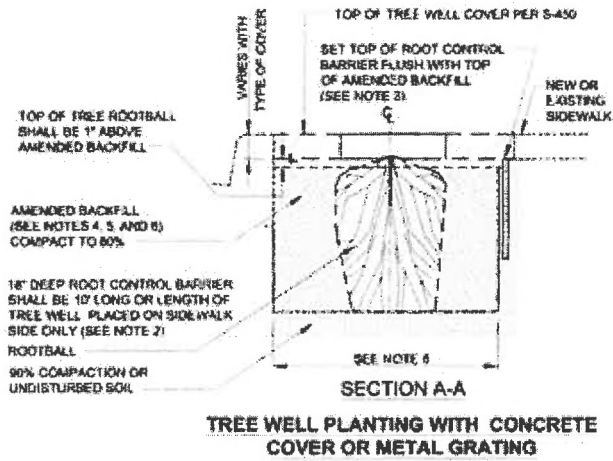

#### Sidewalk Trees

Koelreuteria Trees (Chinese Flame)  
in 5' x 5' Well

#### Ground Plantings & Shrubbery

Boxwood Edge Border

#### Sidewalk Trees

Koelreuteria Trees (Chinese Flame)  
in 5' x 5' Well

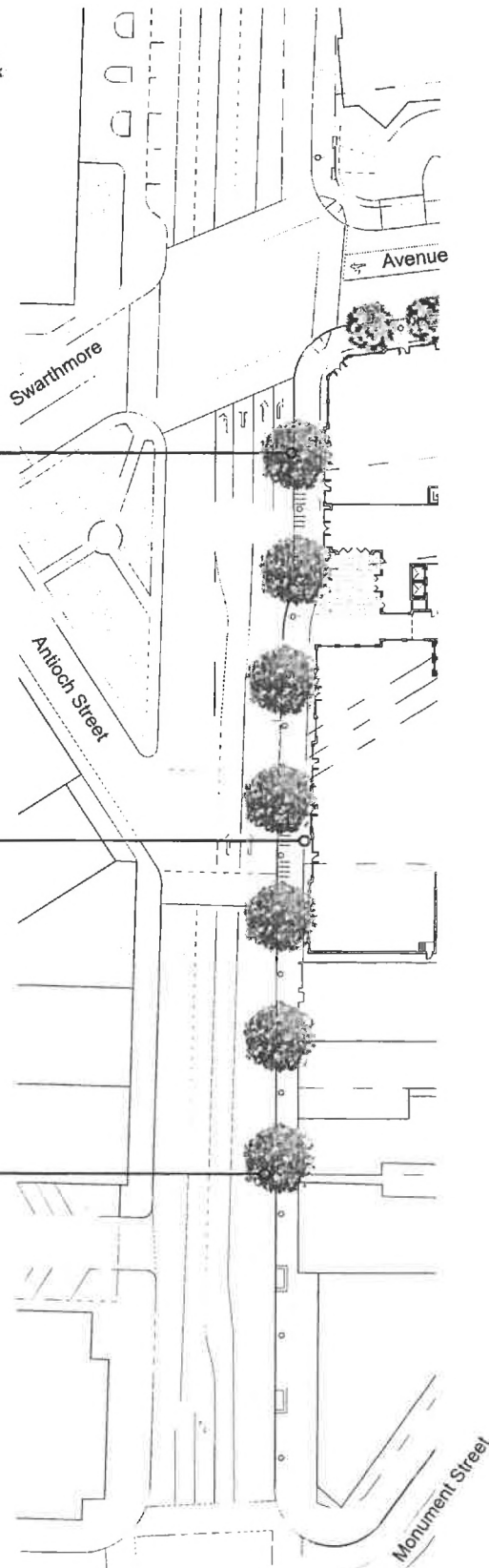

# Appendix A. Streetscape Design

## Monument Street Streetscape Improvements: Street Diagram

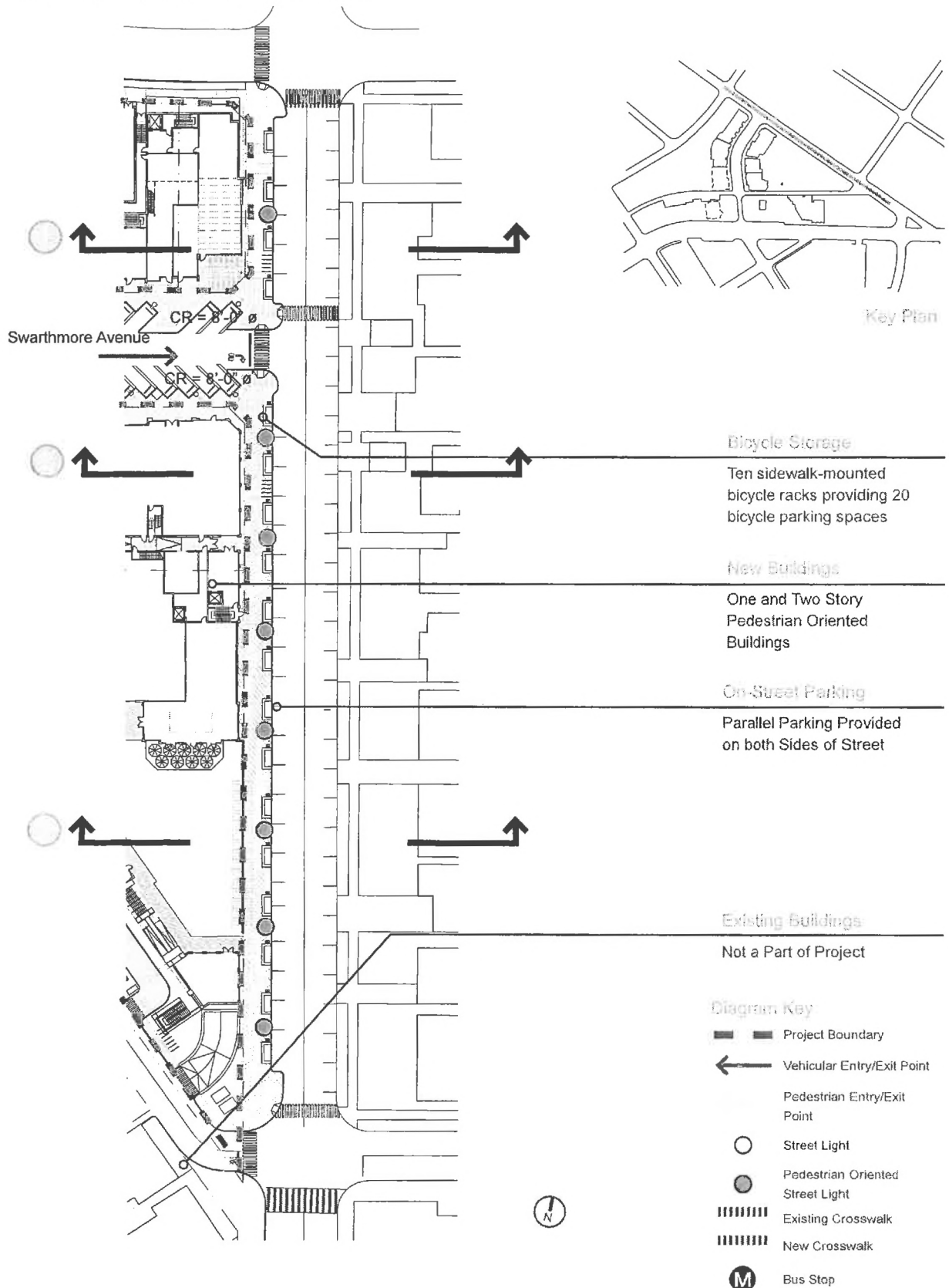

Appendix A. Streetscape Design

Monument Street

Streetscape Improvements: Street Sections

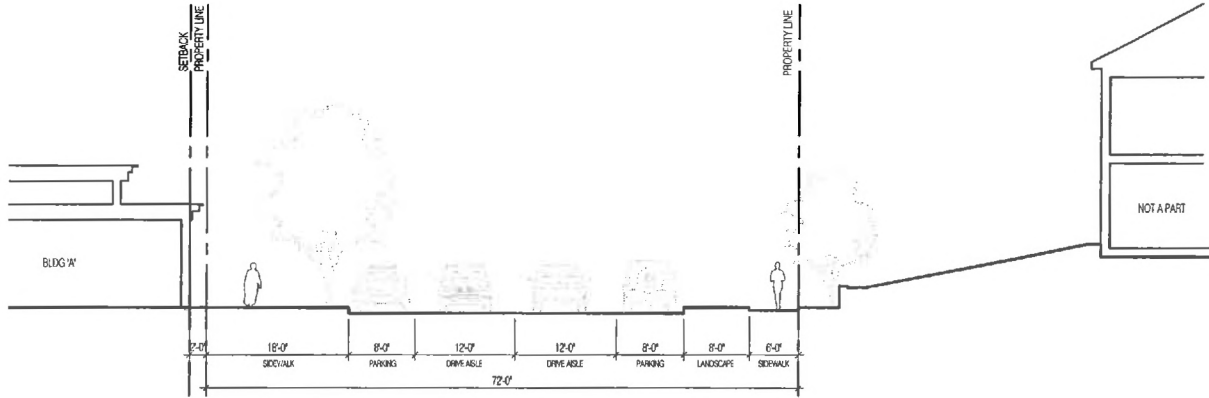

○ Sunset Boulevard Near Intersection of Albright Street

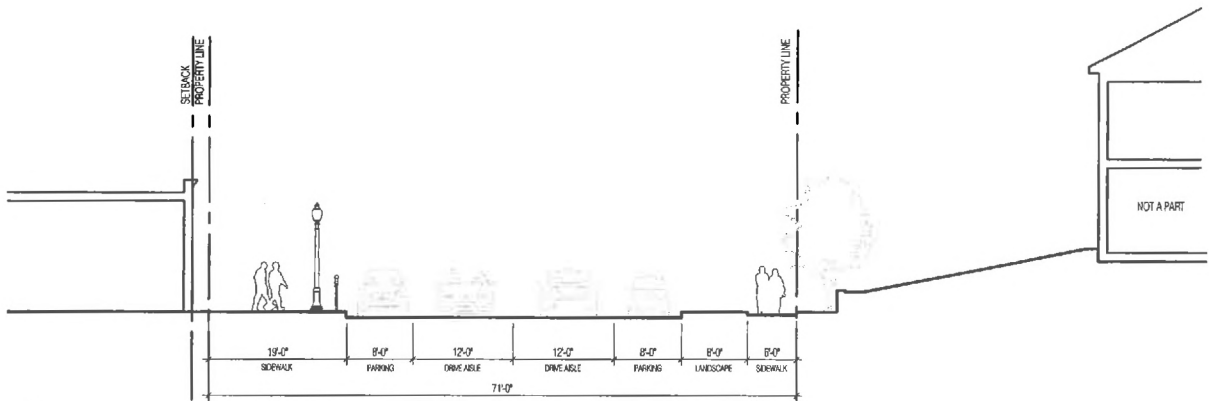

○ Sunset Boulevard Near Intersection of Swarthmore Avenue

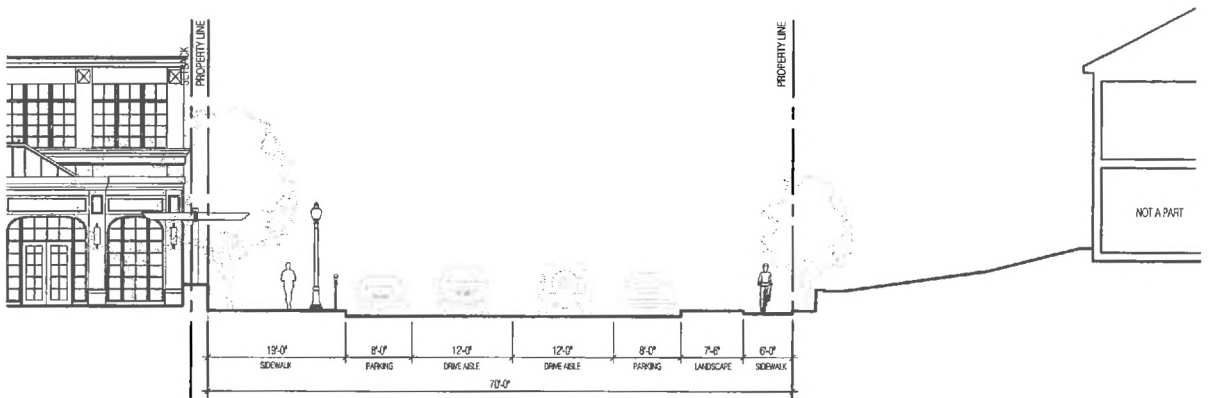

○ Sunset Boulevard at Parking Lot

Appendix A. Streetscape Design

Monument Street  
 Streetscape Improvements: Street Paving Plan

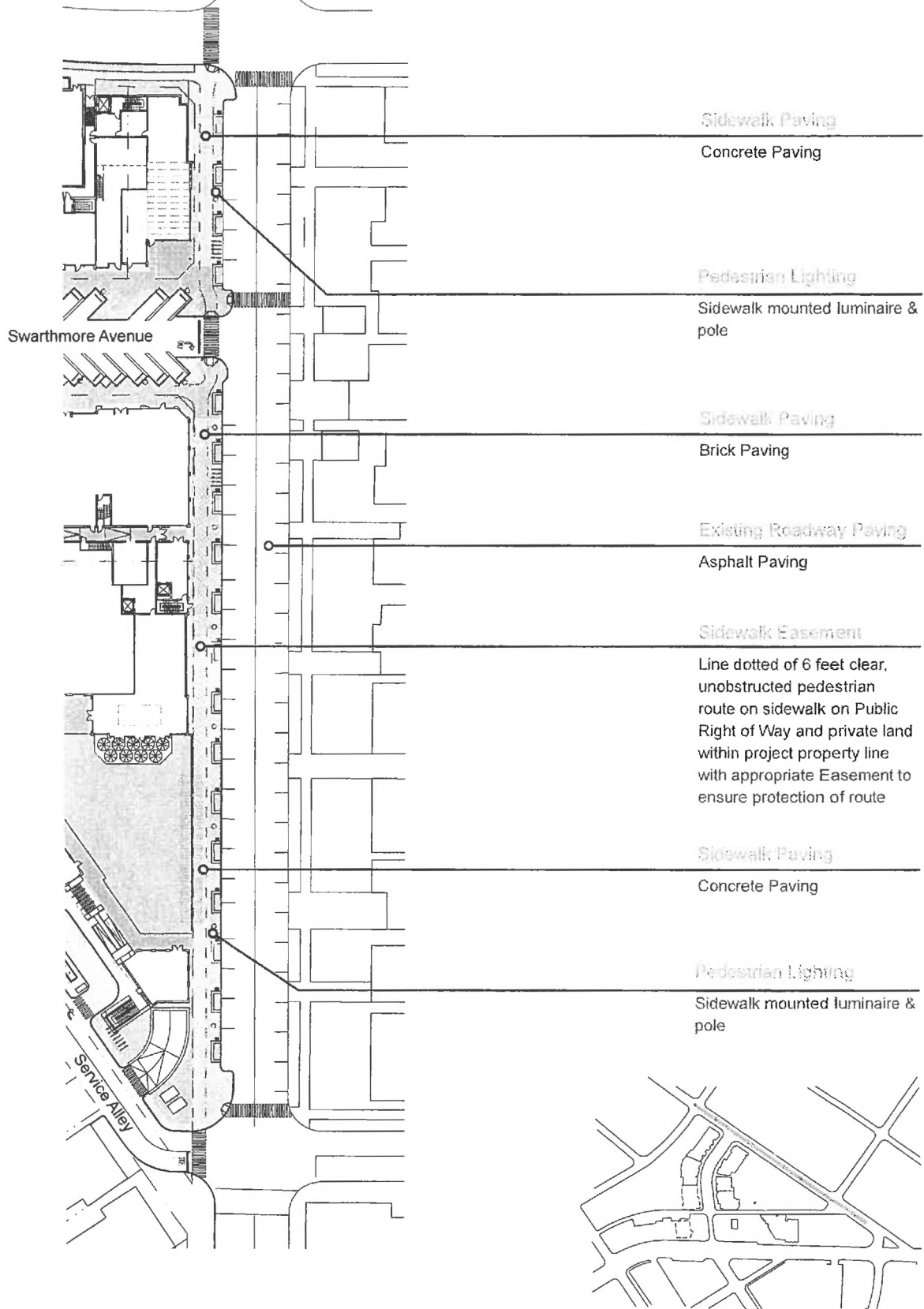

Appendix A. Streetscape Design

Monument Street  
Streetscape Improvements: Street Planting Plan

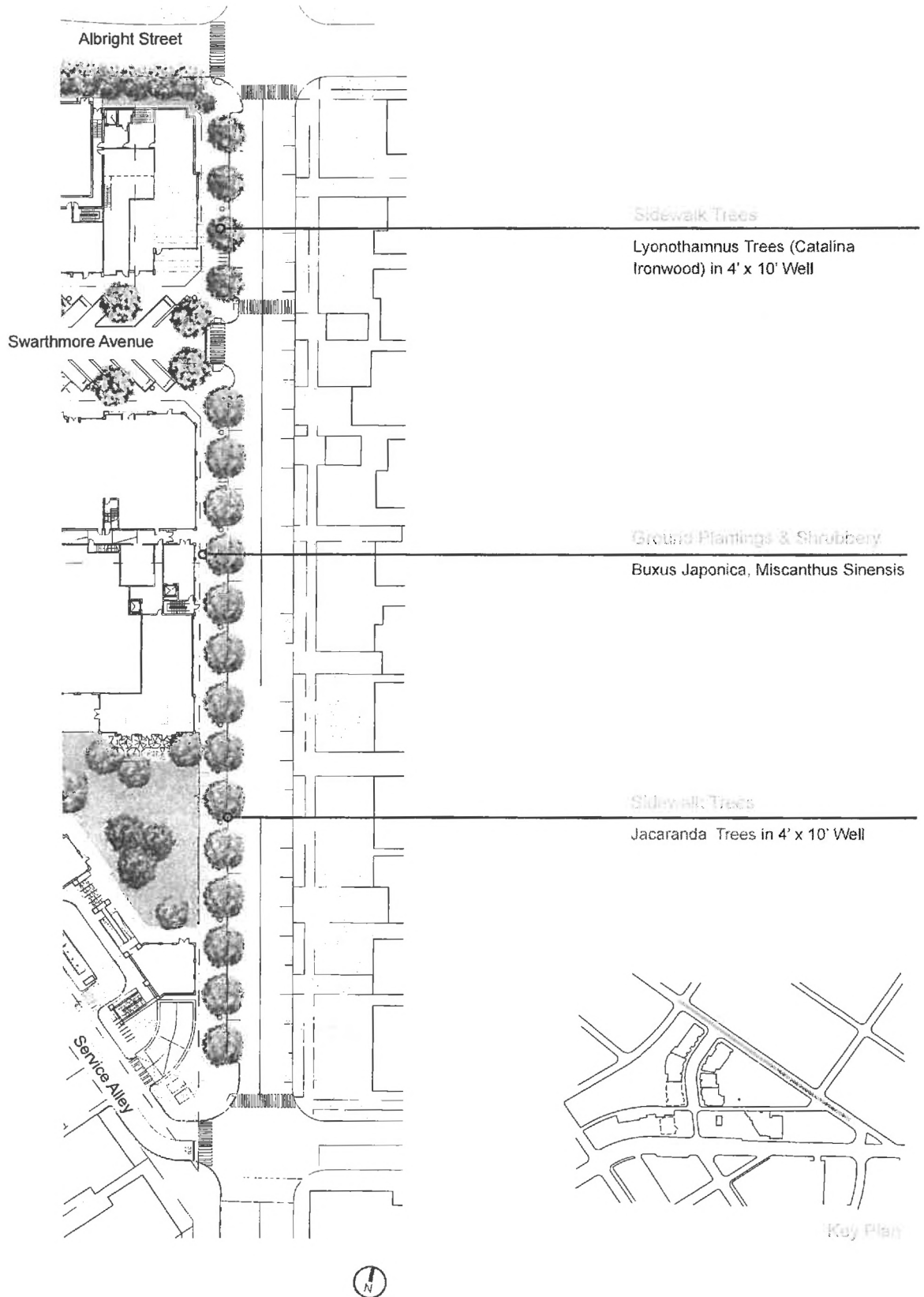

# Appendix A. Streetscape Design

## Albright Street Streetscape Improvements: Street Diagram and Paving Plan

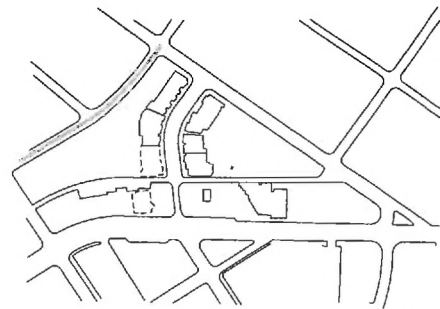

Key Plan

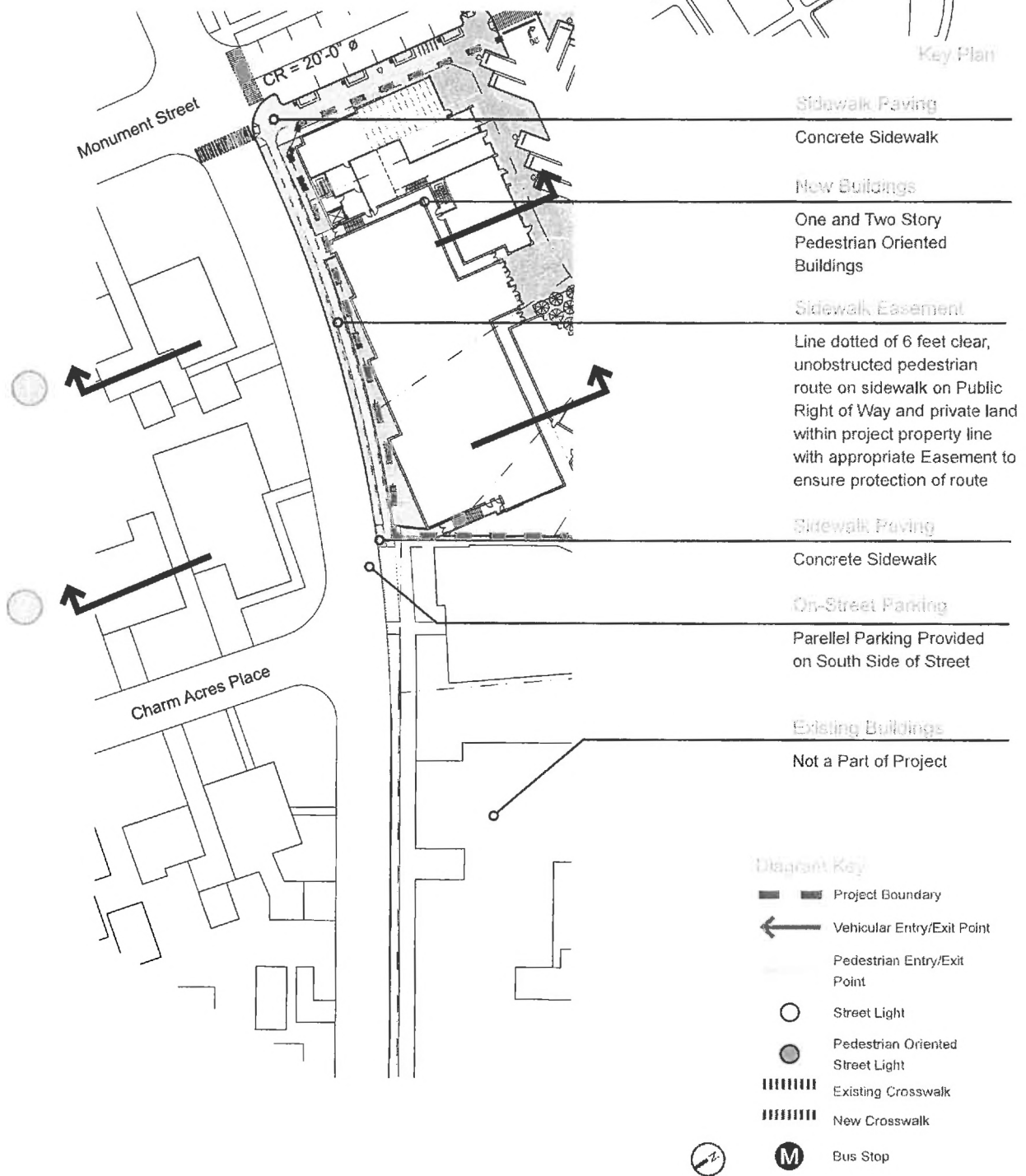

Appendix A. Streetscape Design

Albright Street  
Streetscape Improvements: Street Sections

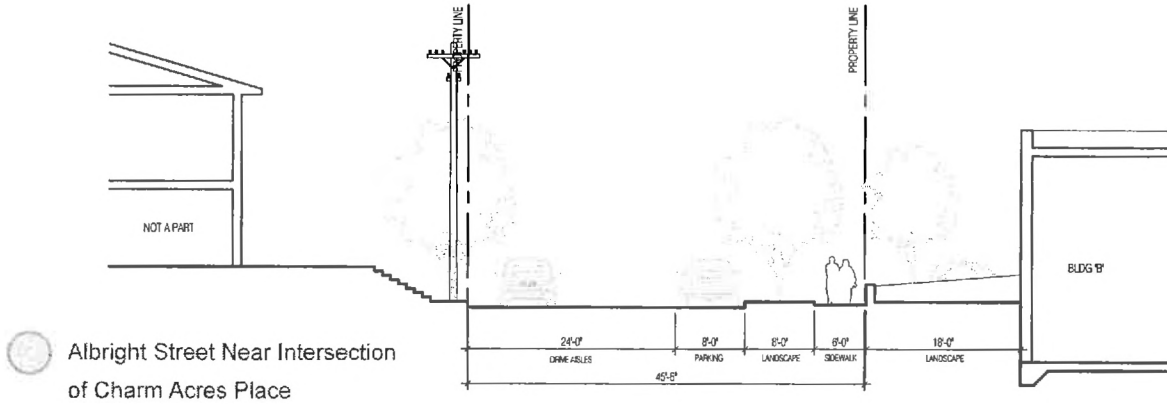
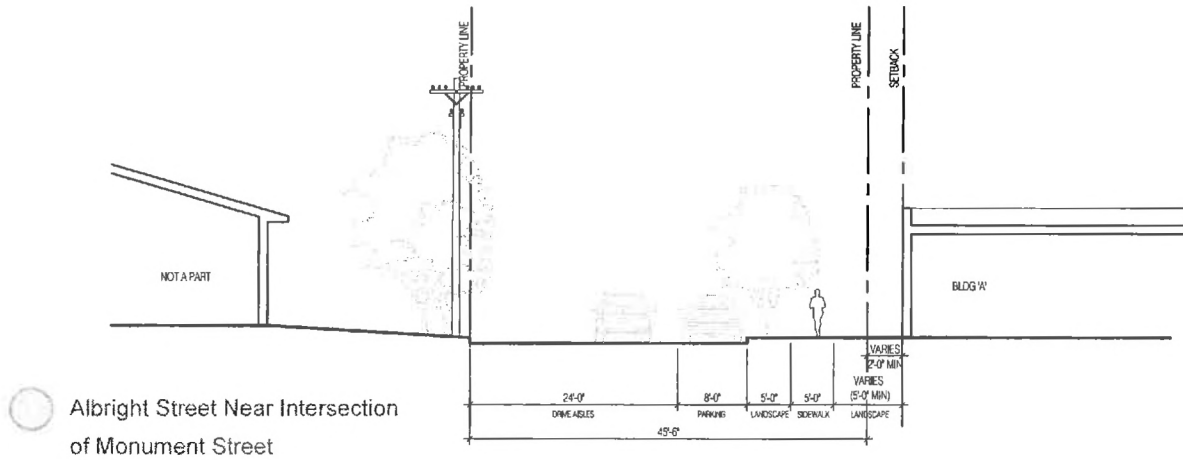

Appendix A. Streetscape Design

Albright Street  
Streetscape Improvements: Street Planting Plan

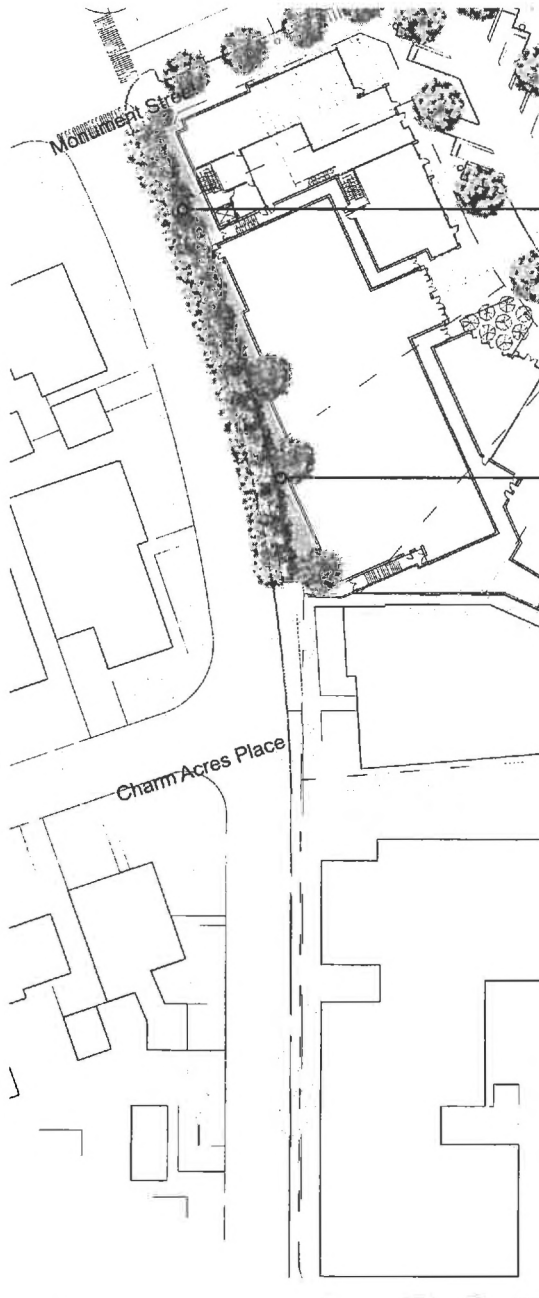
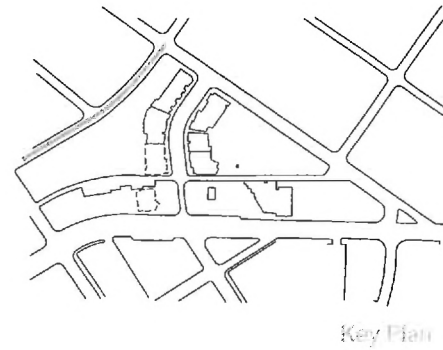

Sidewalk Trees

Lyonothamnus Trees (Catalina Ironwood) in 4' x 10' Well

Ground Plantings & Shrubbery

Chapanula Poscharskyana, agapantha  
Africanus, Ficus Nitada

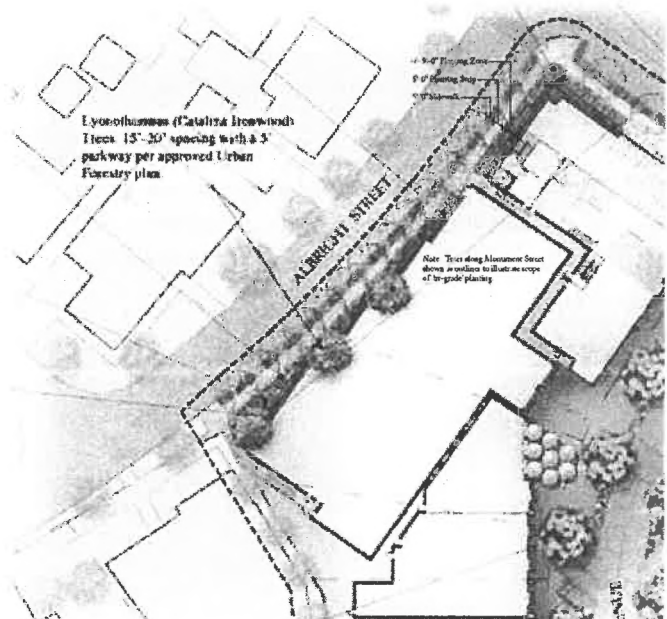

Landscape Plan Extract





# Appendix A. Streetscape Design

## Service Alley

### Streetscape Improvements: Street Diagram

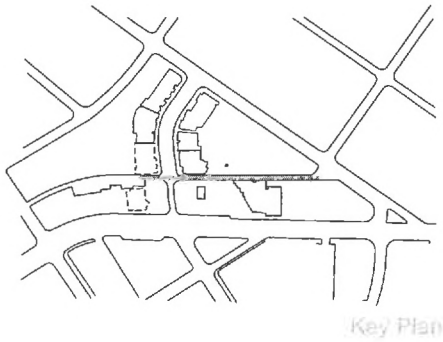

#### New Buildings

One and Two Story  
Pedestrian Oriented  
Buildings

#### Existing Buildings

Not a Part of Project

#### Diagram Key

- Project Boundary
- Vehicular Entry/Exit Point
- Pedestrian Entry/Exit Point
- Street Light
- Pedestrian Oriented Street Light
- Existing Crosswalk
- New Crosswalk
- Bus Stop

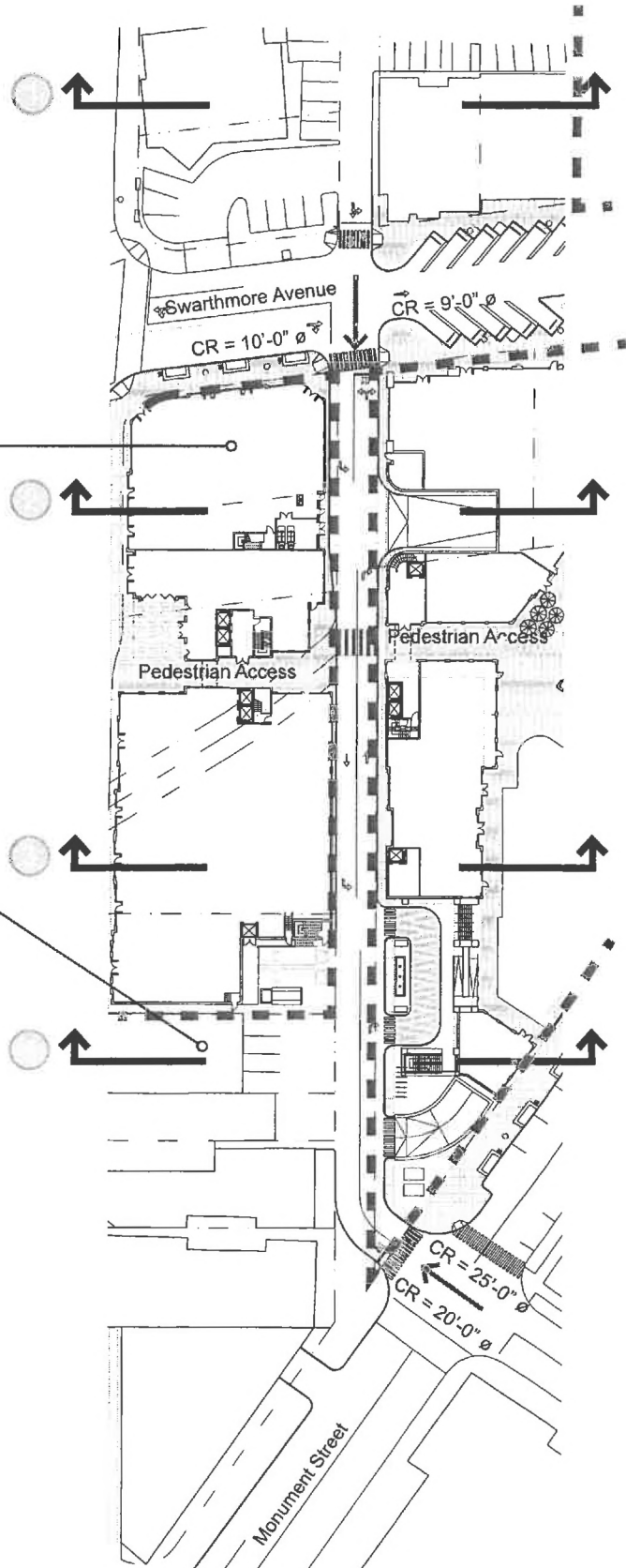

# Appendix A. Streetscape Design

## Service Alley

### Streetscape Improvements: Street Sections

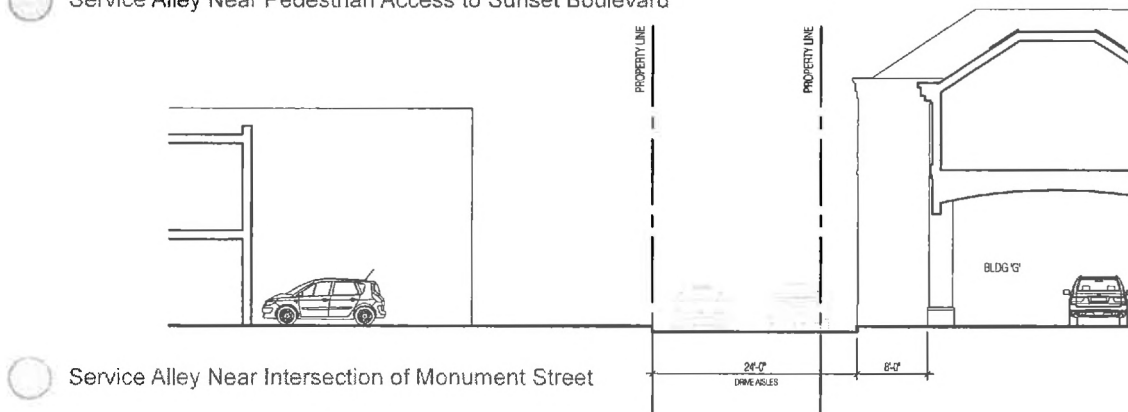
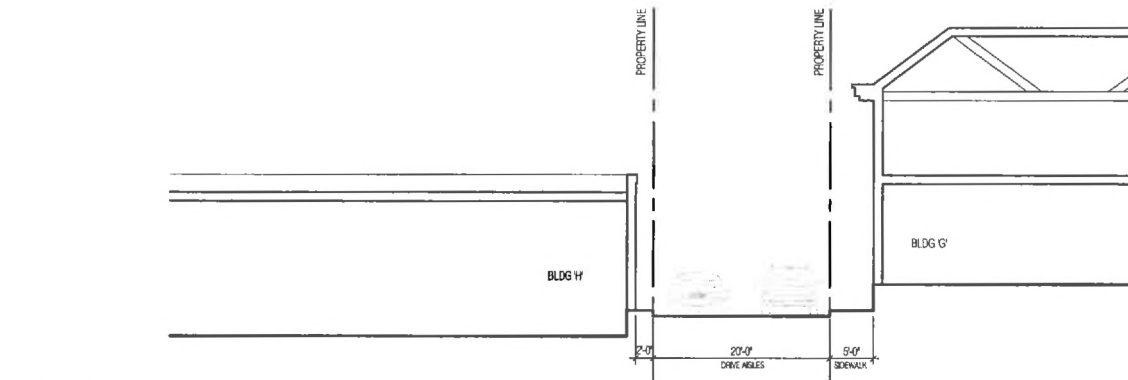
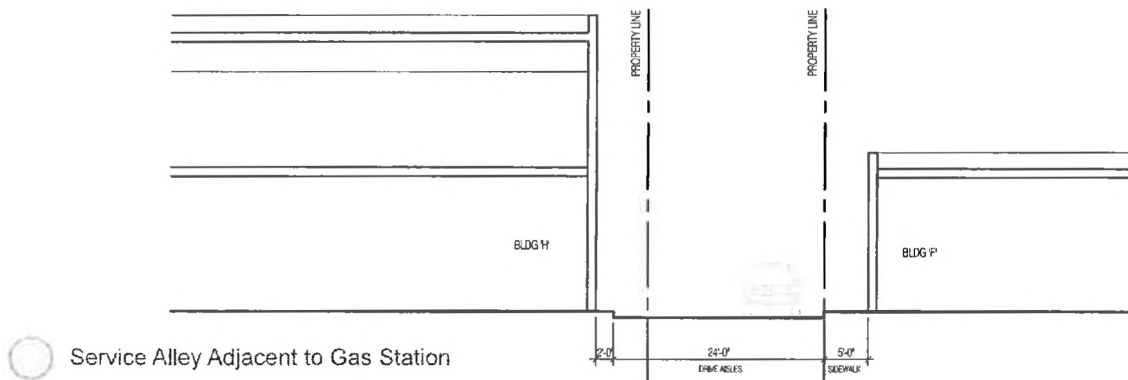
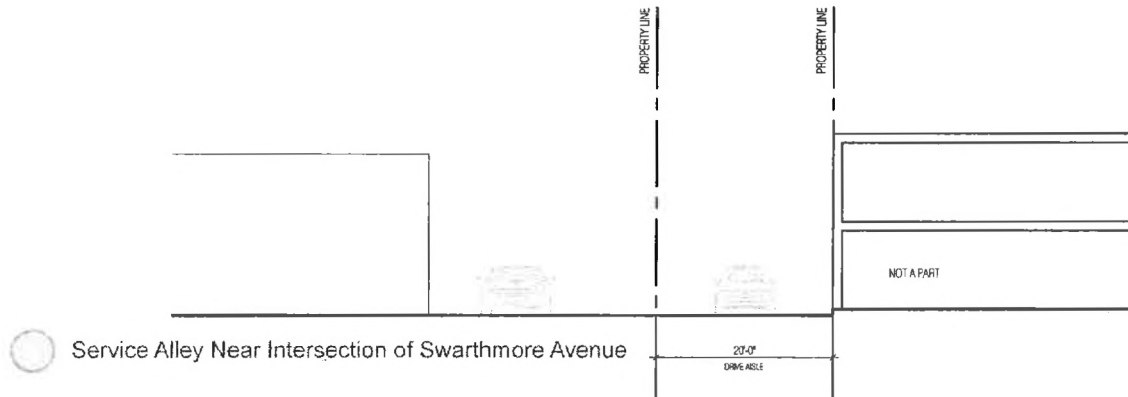

# Appendix A. Streetscape Design

## Service Alley Streetscape Improvements: Street Paving Plan

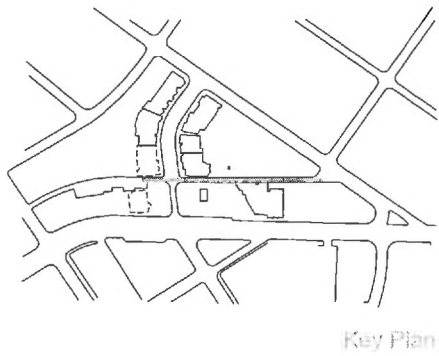

### Sidewalk Paving

Concrete Sidewalk

### Crosswalk Paving

Brick; Herringbone Pattern

### Sidewalk Paving

Brick; Herringbone Pattern

### Sidewalk Paving

Concrete Sidewalk

### Sidewalk Paving

Concrete Sidewalk

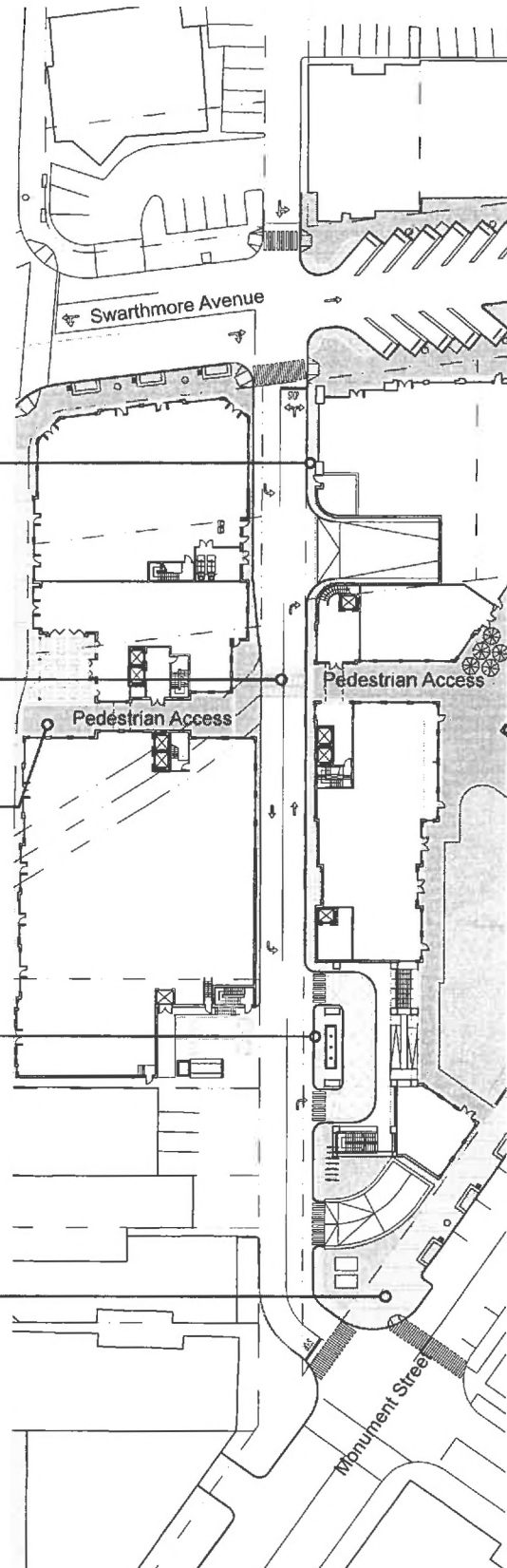

Materials Palette

The Materials Palette includes landscape and street furnishing recommendations for project-wide and street-specific implementation. Guidelines and references to City Standards are included for the location of site furnishings.

**A. Street Trees and Understory Planting**

Trees should be planted from 36-inch boxes, 2-feet back from the curb. Minimum clear distances from infrastructure is defined by the city to be:

- Water and gas meters: 6-feet
- Driveway aprons and cross walks: 6-feet
- Fire hydrants: 10-feet
- Street lights: 20-feet
- Electrical power/Utility poles: 20-feet
- Alley entrance: 20-feet
- Intersection: 45-feet from the projected point of curb line intersection

**1. ALBRIGHT STREET**

*Lyonothamnus floribundus* (Catalina Ironwood) should be equally spaced, 10 feet to 20 feet on-center in a 5-foot wide parkway along the curb. The understory vegetation should be the low growing shrub *Agapanthus africanus* (African Lily).

- a. Figure A.4.A.1.a: *Lyonothamnus floribundus* (Catalina Ironwood)
- b. Figure A.4.A.1.b: *Agapanthus africanus* (African Lily)

**2. MONUMENT STREET**

*Jacaranda mimosifolia* (Jacaranda), should be equally spaced, 20 feet to 30 feet on-center in 4-foot by 10-foot wide planting areas along the curb. The tree and understory planting area should be aligned to allow for access to parallel parked cars. The understory vegetation should be *Dietes iridioides* (African Iris).

- a. Figure A.4.A.2.a: *Jacaranda mimosifolia* (Jacaranda)
- b. Figure A.4.A.2.b: *Dietes iridioides* (African Iris)

**3. SWARTHMORE AVENUE**

*Pyrus calleryana* 'Aristocrat' (Aristocrat Pear) should be equally spaced, 20 feet to 25 feet on-center with 4-foot square planting areas at the end of the angled parking spaces. The understory vegetation should include *Dietes irioides* (African Iris)). Larger planting areas along the avenue should include a perimeter of clipped hedge *Buxus sempervirens* (Common Boxwood) enclosing *Rosa floribunda* 'Iceberg' (White Shrub Rose).



Figure A.4.A.3.a

*Pyrus calleryana* 'Aristocrat' (Aristocrat Pear)



Figure A.4.A.3.b

*Dietes irioides* (African Iris)



Figure A.4.A.3.c

*Buxus sempervirens* (Common Boxwood), *Rosa floribunda* 'Iceberg' (White Shrub Rose)

- a. Figure A.4.A.3.a: *Pyrus calleryana* 'Aristocrat' (Aristocrat Pear)
- b. Figure A.4.A.3.b: *Dietes irioides* (African Iris)
- c. Figure A.4.A.3.c: *Buxus sempervirens* (Common Boxwood),  
*Rosa floribunda* 'Iceberg' (White Shrub Rose)

**4. SUNSET BOULEVARD**

The two mature *Ficus microcarpa nitida* (Indian Laurel Fig), and one *Liquidambar styraciflua* (American Sweetgum), will be removed. Five *Koelreuteria bipinnata* (Chinese Flame Tree) should be equally spaced, 40 feet to 60 feet on-center in 4-foot by 10-foot wide planting areas along the curb. The tree and understory planting area should be aligned to allow for access to parallel parked cars. Understory planting will not be installed.

- a. Figure A.4.A.4.a: *Koelreuteria bipinnata* (Chinese Flame Tree)
- b. Figure A.4.A.4.b: *Strelitzia reginae* (Bird of Paradise)



Figure A.4.A.1.a  
*Lyonothamnus floribundus* (Catalina Ironwood)



Figure A.4.A.2.b  
*Dietes irioides* (African Iris)



Figure A.4.A.1.b  
*Arctostaphylos* 'Pacific Mist' (Pacific Mist Manzanita)



Figure A.4.A.2.a  
*Jacaranda mimosifolia* (Jacaranda)



Figure A.4.A.4.a  
*Koelreuteria bipinnata* (Chinese Flame Tree)

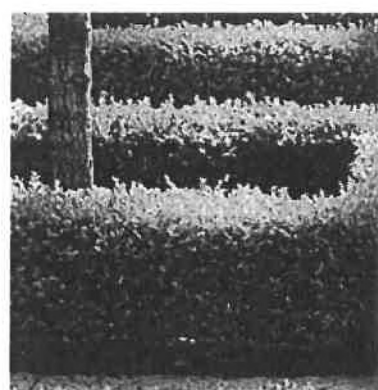

Figure A.4.A.4.b  
*Buxus sempervirens* (Common Boxwood)

**B. Pedestrian Pavement**

The project area public right-of way will meet all the City of Los Angeles standards. The materials, quality and character will extend from the public right-of-way to the building façade, into and through the project.

**1. ALBRIGHT STREET, MONUMENT STREET, ALLEY AND SUNSET BOULEVARD**

Pavement should be natural gray concrete with a light broom finish and scored in a rectangular patterns parallel to the curb. The scoring pattern should be a 12-inch to 18-inch grid to enhance the sense of scale and detail along the sidewalk.

**2. SWARTHMORE AVENUE AND A SEGMENT OF SUNSET BOULEVARD AT THE PASEO ENTRANCE**

Paved with brick or concrete unit pavers. Unit paver sidewalks shall utilize a combination of herringbone, block/stacked & standard coursed patterns. (Figure AA.1) Additional pavement materials should be included to add to the character of Swarthmore Avenue including cast-in-place concrete, scored in 12-inch to 24" squares, stone and concrete pavers (Figure AA.2).

**C. Crosswalks**

Crosswalks will be maintained at the intersections of Monument Street and Bashford Street; Swarthmore Avenue and Sunset Boulevard, Sunset Boulevard and Antioch Street in keeping with the City of Los Angeles standards. Crosswalks will be standard street paint on asphalt. Brick pavers and/or cast-in-place concrete will extend across Swarthmore Avenue between the expanded pedestrian sidewalks lining the cinema plaza and paseo.

**D. Site Furnishings**

Street furniture will meet the City of Los Angeles standards for character, quality and location. A Revocable Permit may be required for the installation of furniture in the public-right-of-way. (Note that the representative street furnishings below are to demonstrate the level of quality and finish. The final selection and design of the street furnishings may be subject to change)

**1. SEATING**

- a. Dumar 165 Series Bench with steel supports painted black with Ipe wood slats. (Figure A.1)

**2. BICYCLE RACKS**

- a. Maglin MBR200 Series Bike Rack, Color/Finish to be black (Figure A.2)

**3. TRASH AND RECYCLING RECEPTACLES**

- a. WITT Industries Oakley M3600R Receptacle, Color to be black (Figure A.3)



Figure AA.1  
Brick sidewalk



Figure AA.2  
Cast-in-place scored concrete



Figure A.1  
Teak Warehouse Bowback Small Bench

**4. BOLLARD**

- a. Fair Weather Bollard Model B-1-6, Color to be black (Figure A.4)

**5. DETECTABLE WARNING SURFACE**

- a. Irondome Cast Iron Tactile Tile (Figure A.5)

**6. PEDESTRIAN LIGHTING**

- a. Custom Light Pole Type A - Based upon DABMAR Post Fixture GM-9000 (Figure A.6a)
- b. Custom Light Pole Type B - Based upon DABMAR Post Fixture GM-9270 (Figure A.6b)

**7. PARKING BUMBERS**

- a. Century Group concrete parking bumper. (Figure A.7)

**8. TREE GUARD**

- a. Ironsmith Tree Guard Model M-3. Color to be black.

**9. TREE GRATE**

- a. Ironsmith Tree Grate Model 3660 ADA. Color to be black. (Figure A.8)

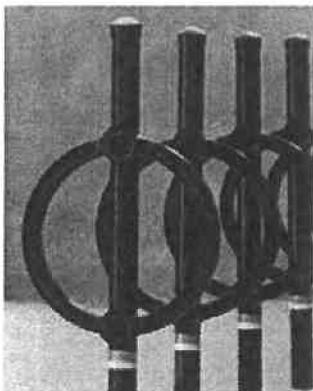

Figure A.2  
Maglin MBR200 Series  
Bike Rack



Figure A.3  
WITT Industries Oakley M3600R



Figure A.4  
Fair Weather Bollard  
Model B-4-6



Figure D.5  
Irondome Cast Iron Tactile Tile



Figure D.6a  
Custom Light Pole Type A - Based upon  
DABMAR Post Fixture GM-9000



Figure D.6b  
Custom Light Pole Type B - Based  
upon DABMAR Post Fixture GM-  
9270

**10. TREE LIGHTING**

- a. SPJ Li'L Beast directional light. Color to be Matte Bronze. (Figure A.9)

**11. BUS SHELTER**

The existing bus stop is south of the project in the triangle island at the intersection of Sunset Boulevard and Monument Street. No shelter exists. A new bus shelter is not included in the Palisades Village project.

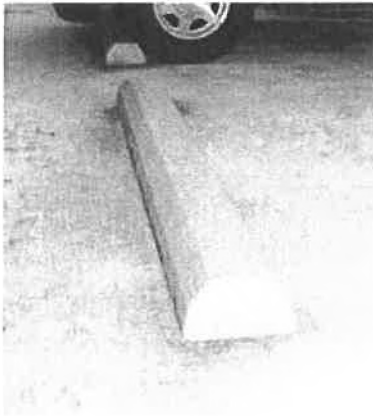

Figure A.7  
Century Group Parking Bumper



Figure A.8  
Ironsmith Tree grate 3660 ADA



Figure A.9  
SPJ Li'L Beast Directional Light



Figure A.10  
Decorative Iron Rail



Site Signage  
Proposed Improvements: Vehicular Wayfinding

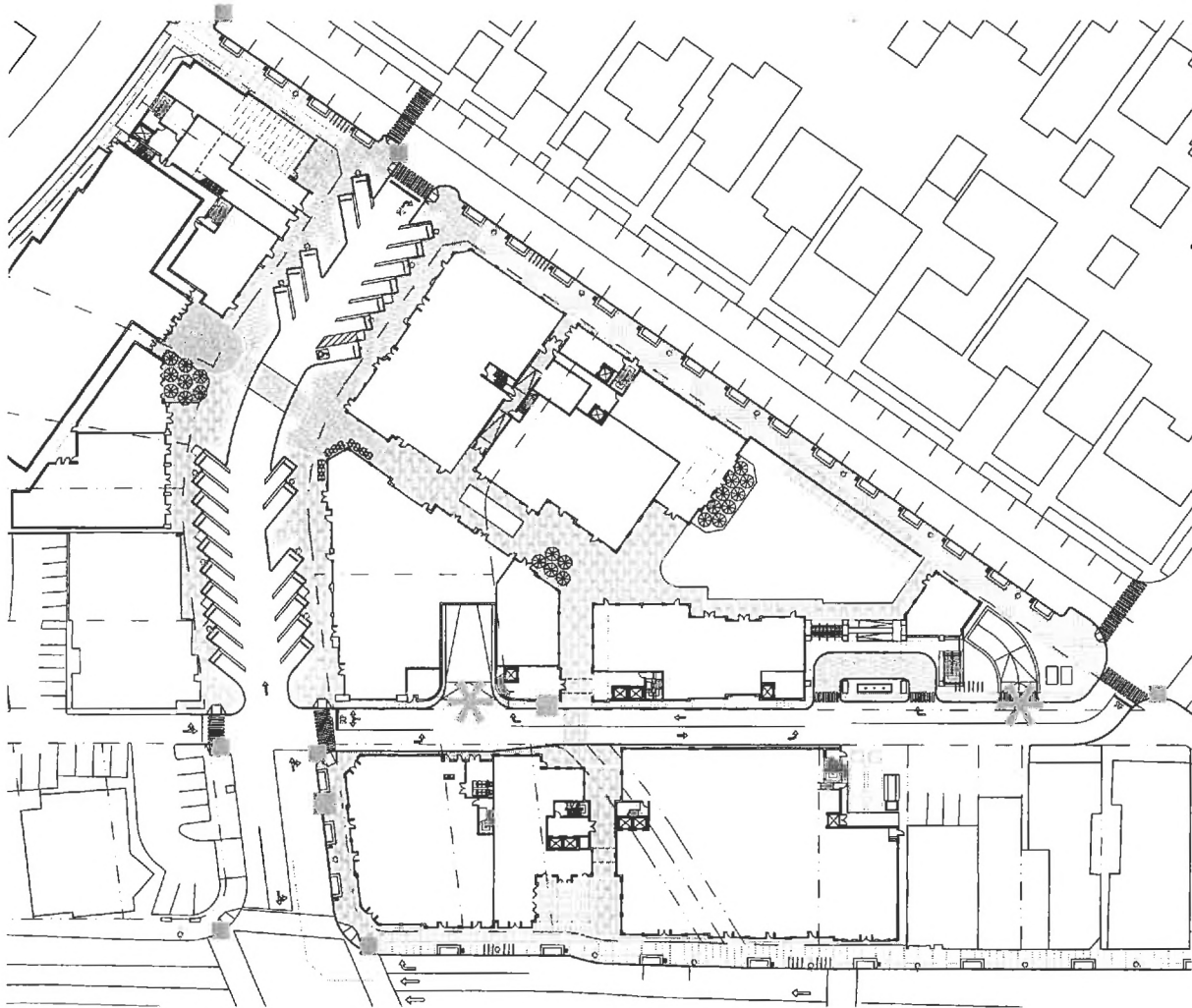

Figure A.11  
Vehicular Wayfinding Sign Types

Vehicular Wayfinding Sign Types

-  Garage Entrance with Clearance Bar to Parking Garage
-  Street ID Sign – This street ID location is optional if there is no entry gateway at this location
-  Vehicular Wayfinding Sign

# Appendix A. Streetscape Design

## Site Signage

### Proposed Improvements: Vehicular Wayfinding

#### Vehicular Wayfinding Sign Family

The sign family below are massing studies of typical wayfinding signs addressing the public garage.

#### Street Name Signage

Example of City of Los Angeles standard

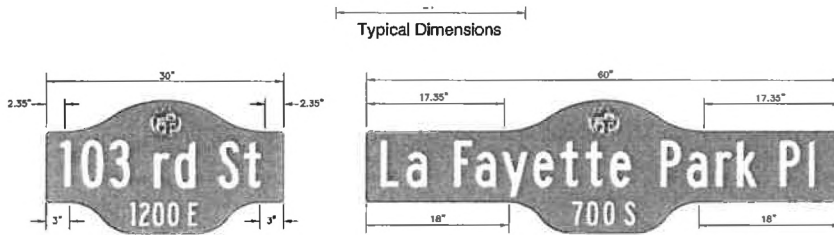

Figure A.12  
Street Name Sign Family

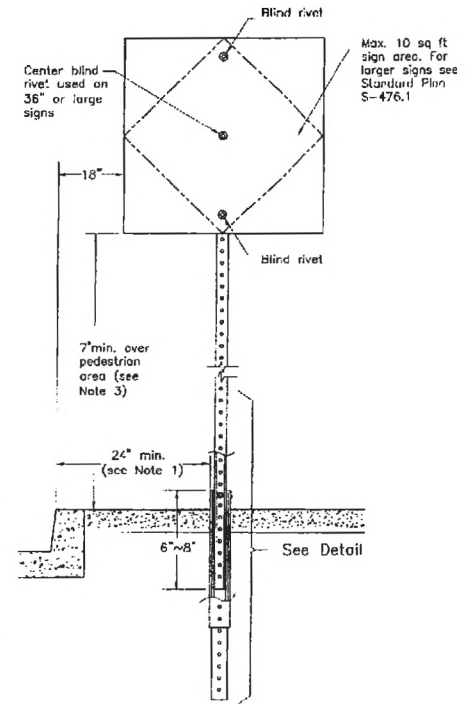
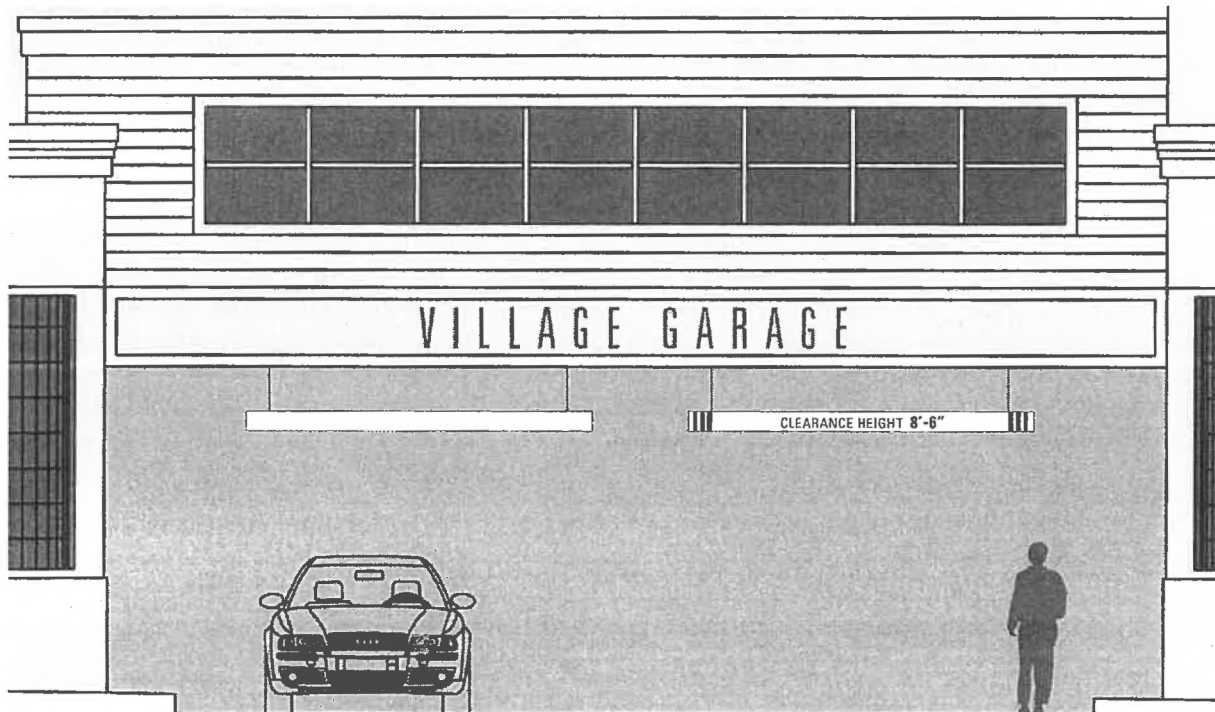

Figure A.13  
City of Los Angeles Standard Sign Pole



Appendix A. Streetscape Design

Site Signage

Proposed Improvements: Vehicular Wayfinding

Vehicular Wayfinding Sign Family

The sign family below are a sidewalk mounted monument sign on Swarthmore and a building mounted sign on the Service Alley to direct vehicular traffic to the public garage.

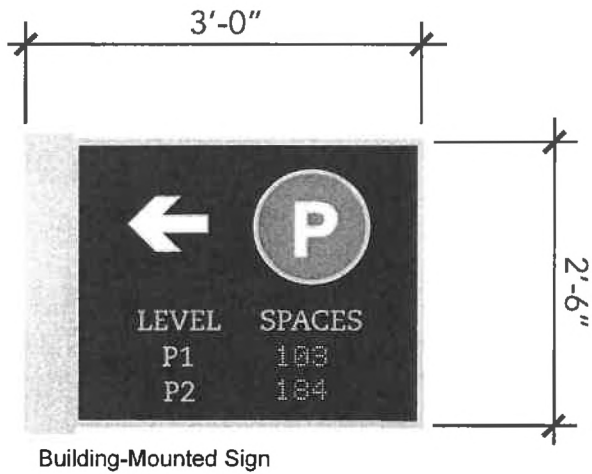

Building-Mounted Sign

Regulatory Sign Family

The selection and mounting of all regulatory signs shall be in accordance with the City of Los Angeles signage standards.

Examples of Regulatory Signs

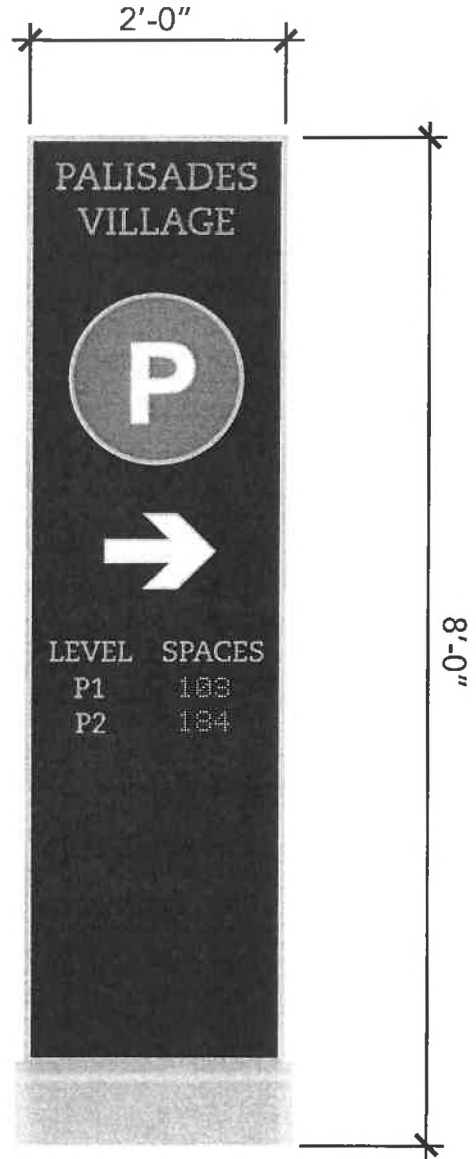

Monument Sign

Figure D.14

Vehicular Wayfinding Sign Family

**APPENDIX B**  
**Master Sign Program**

**Appendix B**  
**MASTER SIGN PROGRAM**

**I. PREFACE**

These Commercial Tenant Sign Regulations ("Sign Regulations") establish standards and criteria for the design, implementation, and regulation of commercial tenant identity signs at the Palisades Village Project (Case No. CPC - 2015-2714-VZC-SP-DRB-SPP) in Pacific Palisades, Los Angeles, California ("Project").

These Sign Regulations have been developed to compliment the design intent of the architecture of the Project and provide a smaller scale of design detail and color that adds vibrancy and character to the Project as well as identifying the Project's amenities and tenants.

**II. OBJECTIVES**

The objectives of these Sign Regulations are:

- To generate creative and tasteful signage that enhances the Project's image and compliments architectural and landscape elements.
- To provide signage that is functional and effectively serves the identification needs of the Project and its tenants.
- To facilitate the review and approval process for signage by providing standards and criteria that constitute standards of acceptability for signs at the Project to be administered and enforced by Owner/Landlord.

**III. SIGN REGULATIONS**

The following are regulations that apply to the development of all signage and graphic elements.

**A. Prohibitions.** The following signs are expressly prohibited:

1. Off-site commercial signs.
2. Roof signs.
3. Window Signs (except store names, store hours, logos, and holiday paintings which must be removed within five business days after the holiday).
4. Animated signs, including flashing neon signs.
5. Bench signs.
6. Pole signs and monument signs.

**B. Requirements.** All signs, except as provided in Subsections C of this Appendix, shall conform to the following criteria:

1. The total sign area shall not exceed two square feet for each of the first 20 feet of building frontage which is adjacent to a public access way and one square foot for each linear foot of building frontage which exceeds the first 20 feet. A public access way can include a street, sidewalk, or paseo in or adjacent to the project.
2. Where buildings or structures occupy a corner site, total sign area shall be 1.5 times the building frontage. For such corner locations, no more than two-thirds of the total allowable sign area shall be permitted facing on any one of the street frontages.
3. For all buildings occupied by several businesses or uses, the size of signs pertaining to each business or use is governed by the proportion of the building frontage occupied by that business or use.
4. Where there is a public entrance from an alley or from a parking lot in addition to the main entrance, there shall be permitted an additional sign area of one-half square foot for each linear foot on that side of the lot, not to exceed 20 square feet in area. If there is no public entrance on that side of the building, sign area is limited to a blade sign, not to exceed three square feet in sign area.
5. No single sign shall exceed 100 square feet in sign area, with the exception of a marquee sign (Section C).
6. Marquee signs and signs attached to awnings may not project above the marquee or awning; may not extend more than 12 inches below the marquee or awning; and shall be at least eight feet above the sidewalk or ground.
7. One Symbol Sign shall be permitted for each business or use and is not included in aggregate size limits. A Symbol Sign may not exceed three square feet in total area and must project from the building or structure or wrought iron brackets of uniform size established by the Design Review Board.
8. Notwithstanding Subsections (c), (d), and (e) of LAMC Section 62.132, banners shall only be permitted if (a) the banner is hung on a 4-foot flag pole; (b) it is attached to the front of a building or structure; and (c) there is clearance of at least 12 feet above the adjacent grade. Banners shall be a uniform size of four by two and one-half feet and may not be displayed for more than 30 days.
9. All signs, other than those described in Subdivisions 6, 7, 8, and 10 of this Subsection shall be parallel to building walls or facades.
10. Temporary Signs inside a building and visible from the outside shall be set back at least six inches from a window and may not be displayed of more than 30 days. The total sign area of such sign shall not exceed 20 percent of the total square footage of the window.
11. No sign shall be attached directly to either the inside or outside of any window or door, except for store names, store hours and logos.
12. Any store hours sign shall be placed in the front door or window closest to the front door. Such sign shall not exceed three square feet in sign area.

**C. Marquee Sign**

1. Allow for a marquee sign up to 30 feet above adjacent sidewalk grade.
2. Allow for a sign area of up to 200 square feet per face. The fixed sign area shall be a minimum of 100 square feet. The fixed sign shall be considered a building identification sign for Building B on Exhibit B, dated May 24, 2016, of the project plans for the Palisades Village Project (Case No. CPC-2015-2714-VZC-SP-DRB-SPP). The physical character of the fixed sign shall match Figure 3 – Marquee Sign Elevation (Enlarged). Off-site messaging is not allowed in the changeable copy area.

**IV. RELATIONSHIP TO SPECIFIC PLAN AND LAMC**

These Sign Regulations supplement the Specific Plan and the Los Angeles Municipal Code with respect to signage for the Palisades Village Project (Case No. CPC -2015-2714-VZC -SP-DRB -SPP). Wherever these Sign Regulations conflict with the provisions of the Los Angeles Municipal Code or the Pacific Palisades Commercial Village and Neighborhoods Specific Plan (“Specific Plan”), these Sign Regulations shall control to the extent of the conflict.

The review and approval procedures for signage within the Commercial Village Subarea A shall be as set forth in Section 13.B.13 of this Specific Plan. The Specific Plan provisions related to Abatement of Nonconforming Signs shall apply to signage within the Commercial Village Subarea A.

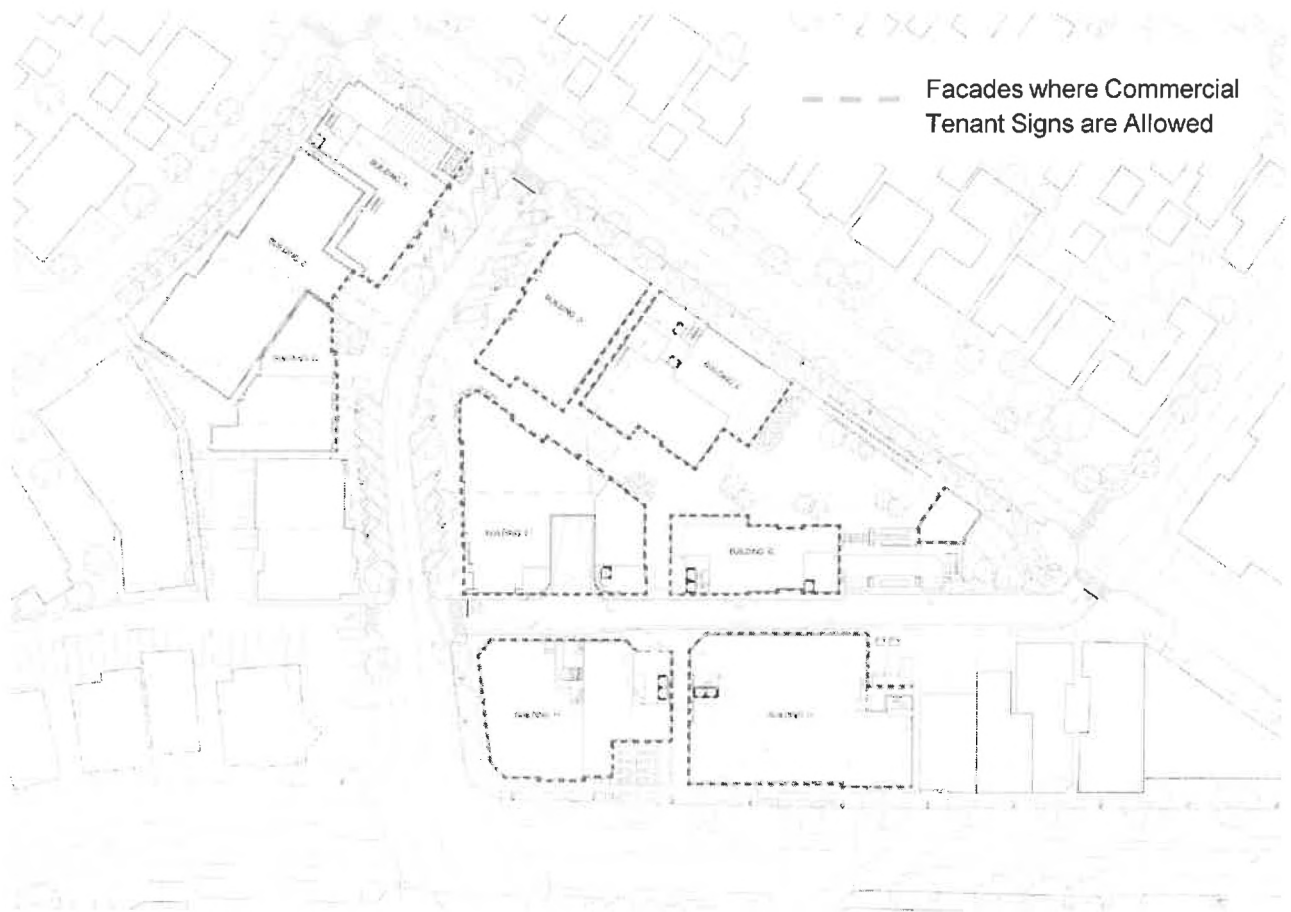

Figure 1— Master Sign Plan

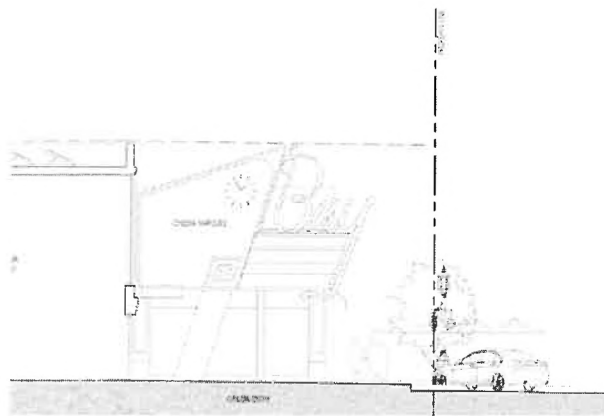

Figure 2— Marquee Sign—Height

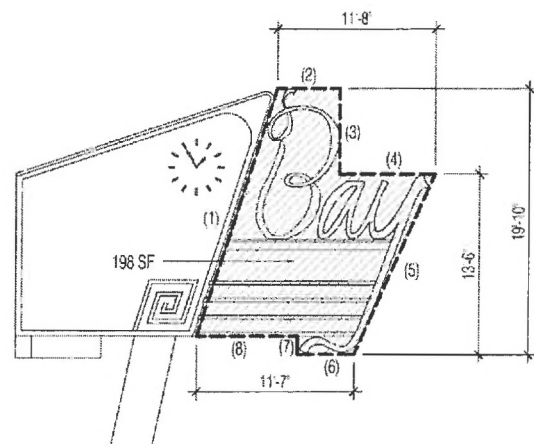

Figure 3—Marquee Sign Elevation (Enlarged)



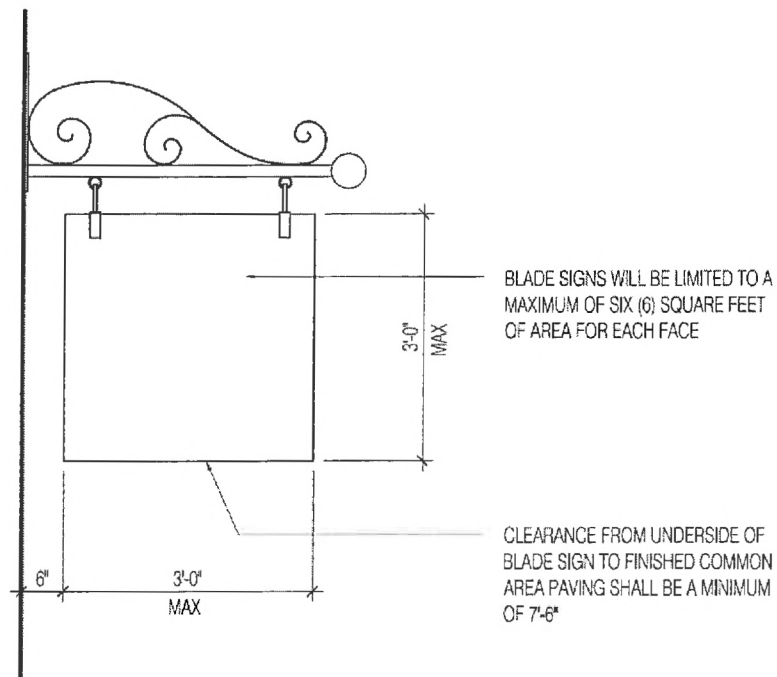

Figure 4 — Tenant Blade Sign Elevation



Figure 5 — Tenant Awning Elevation

#### Tenant Blade Signs

One blade sign shall be permitted for each business or use and is not included in aggregate size limits. A blade sign may not exceed three square feet in total area and must project from the building or structure or wrought iron brackets of uniform size.



Figure 6 — Corner Tenant Storefront Wall Sign

**Corner Tenant Storefront**

Where buildings or structures occupy a corner site, total sign area shall be 1.5 times the building frontage. For such corner locations, no more than two-thirds of the total allowable sign area shall be permitted facing on any one of the street frontages.

**Allowable Signage Area Example**

Frontage	Multiple	Signage Area Allowed
50'-0"	1.5	75'-0" sf

No side may exceed two thirds or 50 square feet of the total allowable sign area.



Figure 7 — Typical Tenant Storefront Wall Sign

**Typical Tenant Storefront**

The total sign area shall not exceed two square feet for each of the first 20 feet of building frontage which is adjacent to a public access way and one square foot for each linear foot of building frontage which exceeds the first 20 feet.

Allowable Signage Area Example

Frontage	Multiple	Signage Area Allowed
20'-0"	2	75'-0" sf

Note that tenant storefronts whose rear facades front a vehicular alley shall also be allowed to place a tenant storefront sign on the rear façade equal in size to the allowable storefront sign per the tenant's frontage, if the rear façade includes a pedestrian entrance.