



DEPARTMENT OF CITY PLANNING

RECOMMENDATION REPORT

City Planning Commission

Date: August 25, 2016
Time: After 8:30 A.M.*
Place: Van Nuys City Hall
Council Chambers, 2nd Floor
14410 Sylvan Street
Van Nuys, CA 91401

Case No.: CPC-2015-4499-CA
CEQA No.: ENV-2015-4500-CE
Council No.: All
Plan Area: Citywide
Specific Plan: N/A
Certified NC: All

Public Hearings: January 20, 2016
January 26, 2016
February 17, 2016

Applicant: City of Los Angeles

PROJECT LOCATION: Citywide

PROPOSED PROJECT: A proposed ordinance amending Section 12.22 C.27 of the Los Angeles Municipal Code to require greater front and rear yard setbacks, create a small lot division of land process for existing "bungalow court" projects, and create a process to establish design standards for Small Lot Subdivision projects with an incidental administrative clearance procedure.

RECOMMENDED ACTIONS:

1. **Recommend** adoption of the proposed ordinance amending LAMC Section 12.22 C.27 (Exhibit A) by City Council;
2. **Adopt** the staff report as the report on the subject;
3. **Approve** the findings included in the report and recommend its adoption by the City Council; and
4. **Recommend** the City Council adopt state California Environmental Quality Act ("CEQA") Exemption No. ENV-2015-4500-CE which is a determination based upon the whole of the administrative record, pursuant to CEQA Guidelines, section 15061(b)(3), the project is not subject to CEQA because it can be seen with certainty that there is no possibility the project may have a significant effect on the environment.

VINCENT P. BERTONI
Director of Planning



LISA WEBBER, AICP, Deputy Director

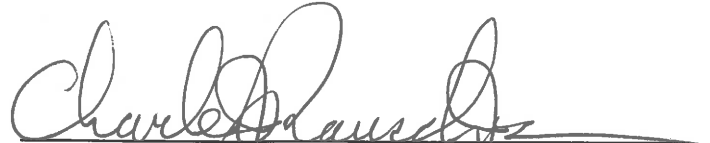

CHARLIE RAUSCH, Associate Zoning Administrator

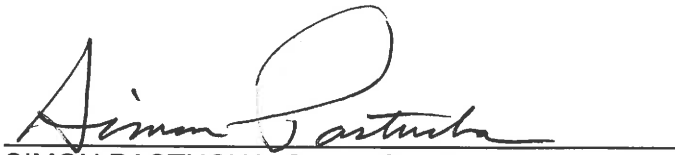

SIMON PASTUCHA, Senior City Planner



JANE CHOI, Senior City Planner



CONNIE CHAUV, Planning Assistant
Telephone: (213) 978-0016



ELAHEH KERACHIAN, Planning Assistant

ADVICE TO PUBLIC: *The exact time this report will be considered during the meeting is uncertain since there may be several other items on the agenda. Written communications may be mailed to the *Commission Secretariat, Room 532, City Hall, 200 North Spring Street, Los Angeles, CA 90012* (Phone No. 213-978-1300). While all written communications are given to the Commission for consideration, the initial packets are sent to the week prior to the Commission's meeting date. If you challenge these agenda items in court, you may be limited to raising only those issues you or someone else raised at the public hearing agendized herein, or in written correspondence on these matters delivered to this agency at or prior to the public hearing. As a covered entity under Title II of the Americans with Disabilities Act, the City of Los Angeles does not discriminate on the basis of disability, and upon request, will provide reasonable accommodation to ensure equal access to these programs, services and activities. Sign language interpreters, assistive listening devices, or other auxiliary aids and/or other services may be provided upon request. To ensure availability of services, please

TABLE OF CONTENTS

Project Analysis	A-1
Project Summary.....	A-1
Background.....	A-1
Small Lot Ordinance No. 176,354	
Small Lot Subdivision Statistics	
Council Motions	
Update Process	
Small Lot Code Amendment Highlights	A-3
Overview	
Administrative Clearance Process for Design Standards	
Lot Width and Lot Area Coverage	
Changes to Front, Rear, and Side Yards	
Bungalow Court Small Lots	
Proposed Small Lot Design Standards	A-6
Small Lot Map Standards.....	A-7
Issues.....	A-7
Zones Permitting Small Lot Projects	
Affordable Housing and Small Lot Subdivisions	
Density, Height, Setbacks and Massing of Small Lot Subdivision Projects	
Guest Parking, Open Space and Trash Collection	
Conclusion	A-9
Findings.....	F-1
General Plan/Charter Findings	
CEQA Findings	
Public Hearing and Communications.....	P-1
Exhibits:	
A – Revised Draft Ordinance	
B – Revised Draft Small Lot Design Standards	
C – Advisory Agency Map Standards	
D – Sample Illustrations for Small Lot Guide	
E – Small Lot Statistics 2005-2016	
F – CEQA Narrative for Categorical Exemption - ENV-2015-4500-CE	

PROJECT ANALYSIS

Project Summary

The project is a proposed ordinance amendment to update the Small Lot Subdivision Ordinance (“SLS Ordinance”) (Section 12.22 C.27 of the Los Angeles Municipal Code) to require greater front and rear yard setbacks, create a division of land process for the preservation of bungalow courts as Small Lot Subdivisions, and to enable the establishment of design standards with an administrative clearance process for Small Lot Subdivision projects.

The proposed ordinance (“Ordinance Amendment”) is part of a comprehensive update of the SLS Ordinance that is in response to City Council Motion 13-1478 and numerous project appeals and community discussion on prior Small Lot Subdivision applications.

- The Ordinance Amendment will require greater front and rear yard setbacks and greater setbacks when abutting single-family or more restrictive zones, create a division of land process for existing “bungalow court” small lot projects, and establish design standards for small lot subdivision projects with an incidental Administrative Clearance process.
- The Design Standards will create specific and enforceable rules regarding design for all small lots, including building orientation, primary entryways, façade articulation, roofline variation, building modulation, pedestrian pathways, landscaping, and common open space areas. All small lot subdivisions must comply with the Design Standards through an Administrative Clearance process.
- The Map Standards created through the authority of the State Subdivision Map Act will update map provisions for all small lots, including common access driveways and walkways, utility easements, maintenance agreements, vehicular guest parking, on-site trash pick-up, and open space easements. The Map Standards will become effective by the Department of City Planning Advisory Agency memo and will be implemented alongside the Code Amendment and Design Standards.

The intent is to update existing regulations to ensure small lot projects will be more sensitive and compatible with the existing neighborhood context and zoning. The proposed Ordinance Amendment, Design Standards, and Map Standards will limit the buildable area of the lot, require greater setbacks, and establish standards for guest parking and access, building entry orientation, pedestrian access, and landscaping.

Background

Small Lot Ordinance No. 176,354

In 2005, the City of Los Angeles adopted a Small Lot Subdivision Ordinance (“SLS Ordinance”) to allow the construction of homes on small lots with fee-simple ownership on lots zoned for multiple family development. The resulting “Small Lot Homes” were intended as infill development and a smart growth alternative to traditional suburban style single-family subdivisions on sites zoned for apartment or condominium development.

The SLS Ordinance created incentives for infill residential development in areas zoned for multi-family and commercial uses to spur more fee-simple housing production and not increasing the allowed density permitted by the zone. While the SLS Ordinance has created new homeownership opportunities to the traditional single-family home or a condominium, small lot projects typically face challenges related to spatial planning and neighborhood compatibility.

For instance, unique characteristics of Small Lot Subdivisions include reduced front, rear and side yards, reduced passageways, and exemptions from open space and guest parking regulations required of all multi-family and condominium projects, respectively. Given the difficulty of spatially fitting multiple Small Lot Homes within one infill parcel, Small Lot Subdivisions are often designed in a “row home” style and the number of units proposed is below the maximum density allowed on the site.

Small Lot Subdivision Statistics

Since the implementation of the SLS Ordinance, approximately 331 Small Lot Subdivision projects have been approved, yielding a total of 3,412 Small Lot Homes. To date, 1,277 lots have been recorded with the County Assessor’s Office. Small Lot Subdivision approvals constitute approximately 9 percent of all map applications filed with the Department of City Planning. The average size of a small lot project is 10 homes, while the median number of homes is 6. While spread throughout the City’s 35 Community Plan Areas, the Community Plan Areas with the largest proportion of small lot activity include:

Community Plan Area	Percentage of Cases Approved	Percentage of Units Approved
Silverlake – Echo Park – Elysian Valley	14.2%	13.5%
Hollywood	12.3%	9.4%
Venice	11.7%	3.2%
Northeast Los Angeles	9.2%	9.0%
Van Nuys	3.7%	12.6%

In addition, many projects are new investments in areas that have not seen new development within the vicinity and are currently underdeveloped with single-family homes or duplexes despite underlying multi-family zones. Several appeals have been filed by aggrieved parties in response to Small Lot Subdivisions, with common points of appeal including concerns regarding density, scale and massing, and lack of compliance with the Small Lot Design Guidelines. Since 2014, appeals were filed for roughly 22 percent of Small Lot Subdivision projects. This is in comparison to a 11 percent appeal rate in the first 8 years of ordinance implementation. The overall appeal rate since the SLS Ordinance was adopted is 16%.

Council Motions

In addition, since 2014, a series of Council motions have been filed regarding Small Lot Subdivisions. In July 2015, Council Motion 13-1478-S3 was filed to instruct the Department of City Planning to report on:

- Potential updates to the SLS Ordinance and Guidelines;
- Adaptive reuse incentives that could apply to existing bungalow courtyards;
- Enforcement of SLS Guidelines, including trash collection and guest parking; and
- Creating a unique set of requirements applicable to small lot projects of 20 or more units to include quality urban design and sufficient project open space.

The proposed Code Amendment is in response to the Council Motion by establishing enforceable Design Standards for Small Lot Subdivisions, a division of land process for existing bungalow courtyards, and a unique set of requirements for small lot subdivisions creating 20 or more units.

Update Process

After eleven years of implementation, and in response to recent appeals and Council Motion 13-1478-S3, the Department of City Planning has identified key updates that will continue to promote the smart growth of neighborhoods and enhance livability through small lot projects. The Department of City Planning is proposing to translate select Design Guidelines into newly-created Small Lot Design Standards, and establish a Code-required process whereby projects must adhere to the Standards. The SLS Code Amendment and Policy Update (“Code Amendment”) is necessary in order to make the Small Lot Subdivision approval process more straightforward and reduce the number of development issues that often lead to an appeal of a parcel or tract map approval by the Deputy Advisory Agency.

Throughout the update process, the Department of City Planning has been engaged in an extensive public outreach process for the proposed amendments to the SLS Ordinance. In January 2016, the draft Ordinance Amendment and Design Standards were issued for public review and comment, followed by three open houses / public hearings at various locations throughout the City to gather input from both community members and the development community. Due to the comments received during the public hearing and outreach process, the Department has taken additional time to further refine the language of both the Ordinance Amendment and Design Standards.

In June 2016, a revised draft of the Small Lot Code Amendment and Policy Update was released to the public for an additional 60-day public comment period. The June 2016 draft includes refinements that are in response to the comments received. Additional comments were received from focus group meetings and email correspondence.

The additional feedback received in the second round of public comments are addressed and/or incorporated in the drafts in Exhibit A-C and summarized in the “Public Hearings and Communications” section of this report.

Small Lot Code Amendment Highlights

Overview

The Code Amendment proposes to require greater front and rear yard setbacks, create a small lot division of land process for existing “bungalow court” projects, and establish design standards for Small Lot Subdivision projects with an incidental administrative clearance process. The following table summarizes the primary changes with the proposed Code Amendment:

Topic	Existing Limitation	Proposed Change
Procedures	Applicant files for Vesting Tentative Tract Map or Parcel Map. Compliance with design guidelines is flexible.	Applicant files for Administrative Clearance in addition to Tract or Parcel Map, which requires conformance with Small Lot Design Standards.
Lot Width	Requires minimum 16’ lot width.	Requires minimum 18’ lot width.
Buildable Lot Area	Lot coverage limited to 80%.	Lot coverage limited to 75%.
Internal Yards	No yards required along interior lot lines.	(No change).
Perimeter Yards		
Front Lot Line	No yards required along front lot line.	Requires front yard requirements per underlying zone (generally 15’) along front lot line.
Rear Lot Line	Requires 5’ yard along rear	Requires 10’ rear yard (or per

	lot lines.	underlying zone if abutting R1 or more restrictive single-family zone).
Side Lot Line	Requires 5' yard along side lot lines.	Requires 5' side yard (or per underlying zone if abutting R1 or more restrictive single-family zone).
Fences and Walls	Limits to 3.5' fence height if along front lot line, and 6' if along side and rear lot lines.	(No change).
Bungalow Court Projects	No process outlined.	Alterations to existing dwellings must conform with LAMC 12.23 A and applicable Design Standards. New construction must conform with all Design Standards.

Administrative Clearance Process for Design Standards

The current update of the SLS Ordinance includes, among other changes, the creation of an administrative clearance process to implement, by ordinance, new Small Lot Design Standards to be adopted by the City Planning Commission. The State Subdivision Map Act allows local jurisdictions to impose standards beyond those that govern the design and improvements, or infrastructure and layout, of a subdivision map by local ordinance. The proposed ordinance will require conformance with a set of City Planning Commission adopted design standards.

The establishment of an administrative clearance process through the current SLS Code Amendment will enable the City, by local ordinance, to regulate the design of small lot projects based on the new standards. This enables the review of the buildings and structures that are proposed with the division of land. The application for the Administrative Clearance would be filed concurrently with the filing of the Parcel or Tract Map Small Lot application and the environmental clearance. Compliance with the Design Standards will be determined prior to the required hearing for the Parcel or Tract Map.

In January 2014, the Director of Planning issued the Small Lot Advisory Agency Policy, which introduced the Small Lot Design Guidelines (“Guidelines”) and required that Small Lot Subdivision projects substantially conform or meet the intent of the Guidelines. At the time, the subdivision process lacked such an implementing ordinance that could require compliance with design regulations, and therefore the Guidelines were only recommendations and not mandatory. The establishment of an administrative clearance process through the current SLS Code Amendment will enable the City, by local ordinance, to regulate the design of small lot projects based on the new standards.

Lot Width and Lot Area Coverage

The current minimum dimension for lot width of 16 feet per lot created by the subdivision is being increased to a minimum of 18 feet. The increase in the lot width requirement will encourage more ground floor living spaces and provide additional room for vehicle maneuverability on the driveway for units that incorporate tandem parking.

With regard to lot area coverage, currently, all structures on a lot which includes one or more dwelling units, may, taken together, occupy no more than 80 percent of the lot area, unless the

tract or parcel map provides common open space equivalent to 20 percent of the lot area of each lot not meeting this provision. The update of the SLS Ordinance requires that lot area coverage by all structures not exceed 75 percent of an approved small lot, unless the tract or parcel map provides an open space easement equivalent to 25 percent of the lot area of each lot not meeting this provision. The decrease in lot coverage has the potential to create more open areas within and around each development.

Changes to Front, Rear, and Side Yards

The SLS Ordinance adopted in 2005 requires no front, side or rear yard between lots within an approved subdivision. However, a five-foot perimeter setback is required where a lot abuts a lot that is not created by the Small Lot Subdivision. The typical front and rear yard requirement for most residential zones is typically 15 feet, which is much greater than the typical setback provided for Small Lot Subdivisions. In addition, the minimum side yard requirement for most residential zones is typically 5 feet, with an additional foot required for every story above the second floor.

In order to bring Small Lot Subdivision yard requirements more in line with those of other multi-family development types, while continuing to provide incentives for this typology, the Department of City Planning recommends the following for where a lot abuts a lot that is not created by the Small Lot Subdivision: a revised front yard requirement that defaults to that required by the underlying zone, typically 15 feet; a revised rear yard requirement of 10 feet when the subdivision abuts a multi-family or commercial zone or 15 feet when the lot line abuts a single-family zone; and a revised side yard requirement of 5 feet when the lot line abuts a multi-family or commercial zone or that defaults to that required by the underlying zone when the lot line abuts a single-family zone.

The change to the front, rear, and side yard requirements will bring yard requirements for Small Lot projects more in line with those of other multi-family residential developments. Continuing the reduced internal side yard requirement will ensure that the spatial challenges facing Small Lot projects can be addressed while the changes in the front and rear yard requirements become effective.

Bungalow Court Small Lots

In 2008, the City approved a Small Lot Subdivision for the conversion of the historic Maltman Bungalow Courts into individual “small lots” so that they could be preserved through ownership of the individual units. Bungalow Courts were typically built as individual units on one large lot as rental homes. However, many are deteriorating and currently require multiple variances or exceptions to enable their preservation and rehabilitation. The Code Amendment will enable the reuse of L.A.’s original small lots to become a reality through the Small Lot Ordinance. With the proposed Code Amendment, existing bungalow courts with four or more older detached dwelling units on a single lot with a Certificate of Occupancy issued prior to 1950 may qualify to be subdivided into Small Lot Homes.

Key provisions of the Bungalow Court Small Lot regulations include allowing these developments to retain their non-conforming rights as to yards, parking, driveway access, passageways and density (per Section 12.23 A of the Municipal Code). Any structural alterations or additions must also comply with Section 12.23 A and the “Bungalow Court” Small Lot Design Standards. Enhancements made to Bungalow Courts that are identified as eligible for historic designation must also comply with the Secretary of the Interior’s Standards.

In addition, any new dwellings added to the Bungalow Court Small Lot project will be considered new construction, and are therefore subject to the full provisions of the Ordinance as well as the Design Standards.

Proposed Small Lot Design Standards

The Draft Design Standards were distilled from the Guidelines and translated into enforceable standards. They address topics such as building orientation and entry, façade relief, roofline variation, pedestrian connectivity, and landscaping. The Draft Design Standards were circulated for two rounds of public review during the Public Participation period.

Throughout and upon the completion of the Public Participation period and public hearings, the Department of City Planning made revisions to the Draft Design Standards to clarify the language for straightforward implementation, based on the comments received. Primary revisions include the creation of a menu of design options for primary entryways, façade articulation, and varied rooflines, as well as clarified language from earlier drafts. The Revised Draft Design Standards document is available in Exhibit B, and contain provisions including but not limited to:

- Small Lot Homes abutting a public right-of-way or private street shall orient the primary entryway toward the street;
- All Small Lot Homes shall have a primary entryway. All primary entryways shall provide the address or unit identification, ornamental low-level lighting for illuminating the entry area, a landing area with enhanced paving material, different texture, or color, and incorporate at least three of the menu options for entryway design;
- For any Small Lot Home façade fronting a public or private street exceeding two stories in height, the roofline shall be articulated by incorporating one of the menu options for roofline variation;
- All roof decks not facing a public right-of-way or private street shall be oriented internally to the Subdivision, and be stepped back and screened from abutting neighbors;
- Pedestrian pathways of a minimum width of 3 feet shall be provided from the public rights-of-way to all primary entryways and common areas, such as centralized trash enclosures, guest parking, and open space easements; and
- Any common open space areas shall be located at grade level, contiguous, and readily accessible to all residents. Common open space areas shall be multi-functional and designed to accommodate a range of passive, active, or social uses, with enhancements such as landscaping, activity lawns, picnic pavilion, bench seating, decorative bike racks, dog washing station, retaining or planting mature trees, central mailboxes, and/or children's play areas.

While the Design Standards are not effective until adoption and implementation of the SLS Ordinance, the Department of City Planning recommends that the Design Standards be implemented during a "test" implementation phase. Because the Design Standards are not adopted as regulatory imperatives (an ordinance), they afford the flexibility needed for architects/developers to design within a larger framework of clear and consistent objectives for Small Lot Subdivisions. During the "test" implementation phase, the Department of City Planning may have the authority to "test" the emerging Design Standards on current Small Lot projects to ensure that they are feasible. The intent is to allow a transition period until the revised SLS Ordinance is effective, and to allow City staff, project applicants, and neighborhood

groups to “test” and become familiar with the provisions of the Design Standards on current projects. The City Planning Commission will receive a progress update and may approve the Design Standards for full implementation once the Ordinance is effective by City Council adoption.

Small Lot Map Standards

In accordance with California Government Code 66415, the Advisory Agency is “a designated official or an official body charged with the duty of making investigations and reports on the design and improvement of proposed divisions of real property, the imposing of requirements or conditions thereon, or having the authority by local ordinance to approve, conditionally approve or disapprove maps.” In accordance with LAMC Sec 17.03, the Director of Planning is designated as the Advisory Agency for the City of Los Angeles, and is authorized to appoint a Deputy Advisory Agency to act in such capacity. In addition, in accordance with LAMC Sec 17.04, the Advisory Agency is advised by the Subdivision Committee, whose duty is to meet with the Advisory Agency and make recommendations on all tentative tract and parcel maps. The Subdivision Committee is composed of officers from the Departments of Building and Safety, Fire, Water and Power, Recreation and Parks, Transportation, General Services, as well as Public Works through its Bureaus of Engineering and Street Lighting

As part of regulating a Small Lot Subdivision, the Advisory Agency has issued the Small Lot Map Standards, with regulations that set standards for the design and improvements on a parcel or tract map for access, utility easements, maintenance agreements, guest parking, trash enclosures, and open space. An overview of the draft Map Standards document is available in Exhibit C for reference purposes. The Map Standards will become effective by the Department of City Planning Advisory Agency memo and will be implemented alongside the Ordinance Amendment and Design Standards.

The Map Standards govern the “design” and “improvement” of a map as defined under Section 66418 and 66419 of the Subdivision Map Act. The “design” of a map is defined as “the location and size of all required easements and rights-of-way, traffic access and other specific physical requirements in the plan and configuration of the entire subdivision that are necessary...” The “improvement” of a map is defined as “any street work and utilities to be installed...to be used for public or private street, highways, ways, and easements, as are necessary for the general use...” While the Design Standards govern the three-dimensional structures on the site, the Map Standards govern the design and improvements on the two-dimensional parcel and tract map.

Issues

Zones Permitting Small Lot Projects

Small Lots are not permitted in single-family zones. Small lots can only be developed on multi- or commercially-zoned lots. When Small Lot projects are proposed in a neighborhood developed with single-family homes and multi-family structures, it signifies that they are within an older neighborhood zoned for multi-family uses. In other words, in these neighborhoods, a property with an existing single-family home could be redeveloped with apartments by-right. The Small Lot Subdivision process creates new opportunities for alternative homeownership similar to condos and single-family homes in neighborhoods that could otherwise be developed as multi-family or commercial uses.

Small Lot Subdivision projects are allowed within the R2 Zone under limited circumstances. The SLS Ordinance adopted in 2005 enabled Small Lot Subdivisions in the R2 Zone, provided that

the lot directly abuts a commercial or manufacturing zone. The R2 zone is one of the older zones in the Municipal Code. The SLS Ordinance has very limited applicability in this zone. Since 2005, only one project of over 300 Small Lot projects has been approved on a R2 zoned lot.

Small Lot Subdivision projects can be proposed within areas with Q Conditions and legislatively-adopted specific plans and overlays, such as a Community Design Overlay (CDO) or Historic Preservation Overlay Zone (HPOZ). Small Lot Projects within these areas must comply with all of the Q Conditions or regulations of the specific plan, CDO or HPOZ. In addition to the typical filing of a Small Lot Subdivision case with a parcel or tract map, the administrative clearance, and the environmental review file, a project within a specific plan, CDO, HPOZ, or other overlay is required to file for project approval within that overlay, such as a Project Permit Compliance or Community Design Overlay approval. The SLS Ordinance and Design Guidelines supplement but do not supersede any applicable specific plan, CDO, HPOZ, or other overlays.

Affordable Housing and Small Lot Subdivisions

The SLS Ordinance was intended to spur the creation of infill housing that is a more attainable home ownership option than the traditional single-family home. Small Lot Subdivision Projects were not intended to be developed as housing that is required to be “affordable” based on definitions established within State law or in City regulations. Due to the smaller lot size and compact building footprints, and combined with different financing and ownership structure compared to a traditional condominium or townhome, Small Lot Homes are often comparatively less expensive than a traditional single family home within the same neighborhood. For example, no Homeowners Associations are required to be established for the project, and no Homeowners Association fees are required from property owners. Also, the homes are owned in “fee,” meaning that the homeowner owns both the land and the structure on the small lot. This is in comparison to a traditional condominium or townhome where the unit is owned by the buyer, but common areas are owned collectively. Units within Small Lot Subdivisions do not share a wall with any adjacent unit on the property.

When a Small Lot Subdivision project involves the demolition of rent-stabilized units under the City’s Rent Stabilization Ordinance (RSO), the developers are subject to providing relocation assistance and meet the RSO requirements.

Density, Height, Setbacks and Massing of Small Lot Subdivision Projects

With regards to density and height, Small Lot Subdivisions are bound by the underlying zone; the SLS Ordinance does not regulate density and height. And inversely, due to their spatial challenges, they typically result in fewer units than that permitted with condos and apartments. In addition to the increased setbacks and greater front yards per the underlying zones, the front unit(s) abutting a public or private street will be required to provide either a pitched roof, an open deck, or vertical changes in the roofline – providing roofline articulation and enhancing architectural identity. Combined, they can provide for much needed open space within small lot projects.

Through a combination of changes including yard requirements requiring greater building setbacks (Ordinance), façade, roofline, and building articulation (Design Standards), and access easements (Map Standards), it is estimated that massing will be reduced overall by 10 to 20 percent. With the Code Amendment, the front yard of the underlying zone shall apply to the front lot line of the perimeter of the subdivision, and a 10 foot rear yard shall be required along the Rear Lot Line of the perimeter of the subdivision. Subdivisions abutting any single family zone shall provide larger setbacks within side and rear yards per the underlying zone. This will

introduce more open spaces throughout the projects especially along the perimeter of the subdivision that abuts the street or neighboring lots.

Guest Parking, Open Space and Trash Collection

Open space, among other amenities, is being required for Small Lot Subdivisions that include 20 or more units (“Small Lot Communities”). When the Ordinance was adopted in 2005, it was not anticipated that large housing developments would be utilizing the Small Lot process. It was intended for infill developments and provisions for larger projects were not included. Since implementation of the SLS Ordinance in 2005, roughly 10 percent of all Small Lot projects have had 20 or more units. Because of the scale of the subdivision, these Small Lot Communities require special consideration with regard to site planning, building, and landscaping that are unique from the typical Small Lot Subdivision. These issues include pedestrian accessibility, neighborhood compatibility, connectivity, and community amenities. Collectively, these added provisions establish higher standards in the design and development of Small Lot Communities.

Moving forward, a subdivision that creates a community of small lots involving 20 or more Small Lot Homes will be required to provide open space at a ratio of 30 square feet of open space per unit. In addition, any common open space areas shall be multi-functional and designed to accommodate a range of passive, active, or social uses such as landscaping, activity lawns, picnic pavilions, bench seating, dog washing stations, retaining or planting mature trees, central mailboxes, and/or children’s play areas.

In addition, guest parking will be required on site for projects creating 8 or more Small Lot Homes at a ratio of 0.25 spaces per dwelling unit. The guest parking area shall be readily accessible by all guests and shall abut a Common Access Driveway or a pedestrian pathway.

All Small Lot Subdivisions are now prohibited from locating trash bins on public streets for trash pickup. Instead, small Lot projects are required to provide a centralized trash enclosure or to coordinate with the Bureau of Sanitation for on-site trash pickup of centralized trash. Trash areas and utilities are required to be placed away from the street and public view.

Conclusion

The SLS Ordinance has been a successful tool in the City’s toolkit of providing housing opportunities that merge the benefits of living in a condominium while allowing for homeownership akin to owning a traditional, fee-simple single-family home. The intent is to update existing regulations to ensure small lot projects will be more sensitive and compatible with the existing neighborhood context and zoning. The proposed updates to the SLS Ordinance will ensure that projects are more in line with the requirements that other types of housing projects in multi-family zones are required to meet for the front and rear yards, while continuing to provide relief from development standards that are necessary to continue this unique housing typology. The proposed changes address community concerns regarding issues such as the enforceability of design regulations for Small Lot projects, and will ensure that this typology can succeed in providing another housing option to residents for the next decade and beyond.

FINDINGS

GENERAL PLAN/CHARTER FINDINGS

1. City Charter Section 556

In accordance with **Charter Section 556**, that the proposed ordinance (Exhibit A) is in substantial conformance with the purposes, intent, and provisions of the General Plan in that it would amend regulations to ensure that small lot projects will be more sensitive and compatible with the existing neighborhood context and zoning.

Specifically, the proposed ordinance amendment is consistent with the following goals, objectives, and policies of the General Plan Framework Element and Housing Element.

General Plan Framework

Policy 4.1.8

Create incentives and reduce regulatory barriers in appropriate locations in order to promote the adaptive re-use of structures for housing and rehabilitation of existing units. (P2, P18)

The proposed Code Amendment creates a division of land process for the preservation of bungalow courts as Small Lot Subdivisions. The intent is to allow the preservation and adaptive reuse of existing bungalow courts for the conversion into fee-simple structures for home ownership.

In 2008, the City approved a Small Lot Subdivision for the conversion of the historic Maltman Bungalow Courts into individual “small lots” so that they could be preserved through ownership of the individual units. Bungalow Courts were typically built as individual units on one large lot as rental homes. However, many are deteriorating and currently require multiple variances or exceptions to enable their preservation and rehabilitation. The Code Amendment will enable the reuse of L.A.’s original small lots to become a reality through the Small Lot Ordinance. With the proposed Code Amendment, existing bungalow courts with four or more older detached dwelling units on a single lot with Certificate of Occupancy issued prior to 1950 may qualify to be subdivided into Small Lot Homes.

The proposed Code Amendment also allows existing non-conforming bungalow courts to retain their non-conforming rights as to yards, parking, driveway access, passageways and density (per Section 12.23 A of the Municipal Code), making it simpler for applicants to convert the bungalow courts into small lot homes without demolishing or reconfiguring existing structures.

Implementation Program 24

Formulate citywide development standards that:
a. Enhance and/or conserve the appearance and functionality of residential and commercial areas, including appropriate applications for mixed-use structures that integrate housing with

commercial uses. The following indicates a preliminary list of standards that may be considered.

(1) Encourage and facilitate the assembly of small lots for higher-density housing or mixed-use

The proposed Code Amendment is part of a comprehensive update to the Small Lot Subdivision process that establishes standards for the creation of Small Lot Subdivisions that encourage the integration of Small Lot Subdivisions in existing multi-family residential or commercial zoned neighborhoods. The Design Standards also include standards regarding the design of mixed-use small lots.

General Plan Housing Element

Objective 2.4 *Promote livable neighborhoods with a mix of housing types, quality design and a scale and character that respects unique residential neighborhoods in the City*

The Amendment focuses on changing existing regulations to create Small Lot Subdivisions that exhibit front and rear yard requirements that are more closely aligned with that which is required by a site's zone designation, better respecting unique neighborhood scale and character.

Policy 2.4.1 *Promote preservation of neighborhood character in balance with facilitating new development*

The creation of the "Bungalow Court" Small Lot provisions will incentivize the preservation of this unique typology and neighborhood character on sites that are in danger of being cleared for new development.

Policy 2.4.2 *Develop and implement design standards that promote quality residential development*

The establishment of the Administrative Clearance Process to require adherence to the new Small Lot Design Standards will implement this Policy.

Housing Program 3 *Facilitate the development of Small Lot Subdivisions*

Through ten years of implementation, the City has identified the existing front and rear yard setback exceptions for Small Lot Subdivisions as necessary, but a potential obstacle in moving projects forward in their current form. The Amendment will facilitate the development of Small Lot Subdivisions by bringing the setback exceptions in closer alignment with existing Zoning Code regulations for front and rear yards.

2. City Charter Section 558

In accordance with **Charter Section 558 (b) (2)**, the proposed ordinance (Exhibit A) is in substantial conformance with public necessity, convenience, general welfare and represents good zoning practice.

Public Necessity, Convenience and General Welfare – The Amendment is necessary in order to make the Small Lot Subdivision approval process more straightforward and reduce the number of development issues that often lead to an appeal of a parcel or tract map approval by the Deputy Advisory Agency. Since 2014, appeals were filed for roughly 22 percent of Small Lot Subdivision projects. This is in comparison to a 11 percent appeal rate in the first 8 years of ordinance implementation. Most of the appeals were filed by aggrieved parties, and many cited the lack of compliance with the Small Lot Design Guidelines as an appeal point. The Small Lot Design Guidelines were translated into Small Lot Design Standards, and the Amendment will establish a Code-required process whereby projects must adhere to the Standards. The intent is to reduce the number of issues that often lead to an appeal of a parcel or tract map approval by the Deputy Advisory Agency, and address design considerations early on in the process. Reducing the number of issues will also further convenience and general welfare by reducing barriers to create housing opportunities within the City.

Good Zoning Practice - The Amendment is in substantial conformance with good zoning practice as it continues to implement and respect the adopted zoning on a given site while creating the mechanism to allow Small Lot Subdivision developments to be constructed with more straightforward regulations, promoting this hybrid housing typology.

In accordance with Charter Section 558, and in order to ensure the timely processing of this ordinance, the City Planning Commission authorizes the Director of Planning to approve or disapprove for the Commission any modification to the subject ordinance as deemed necessary by the Department of Building and Safety and/or the City Attorney's Office. In exercising that authority, the Director must make the same findings as would have been required for the City Planning Commission to act on the same matter. The Director's action under this authority shall be subject to the same time limits and shall have the same effect as if the City Planning Commission had acted directly.

CEQA FINDINGS

In accordance with California Environmental Quality Act (CEQA) Guidelines, this Ordinance Amendment is exempt under the State CEQA Guidelines Section 15061(b)(3), as well as the City of Los Angeles CEQA Guidelines, Article II, Section 2, class (m). Section 15061(b)(3) establishes the general rule that CEQA applies only to projects that have the potential to cause a significant effect on the environment, and where it can be seen with certainty that there is no possibility that the activity may have a significant effect on the environment, the activity is not subject to CEQA. In addition, the City's CEQA Guidelines, Article II, Section 2, Class (m) exempt the adoption of ordinances that do not result in an impact on the physical environment. The proposed ordinance amends provisions of the existing Small Lot Ordinance only and is not considered a project under the CEQA Guidelines because there is no development, change in land use, intensity or density proposed as part of this project. Future requests for the approval of Small Lot Subdivisions and the construction of Small Lot Homes will require entitlement applications and individual environmental review. See attached Exhibit F - CEQA Narrative for Categorical Exemption - ENV-2015-4500-CE

PUBLIC HEARING AND COMMUNICATIONS

The public outreach process for the Small Lot Subdivision Code Amendment and Policy Update occurred in two rounds over a thirteen month period from July 2015 to August 2016, and targeted both members of the public citywide as well as developers and architects of Small Lot Subdivision projects. The public outreach process generated responses regarding topics such as affordable housing, neighborhood character, and design of small lot projects. Below is a summary of the outreach conducted and comments received.

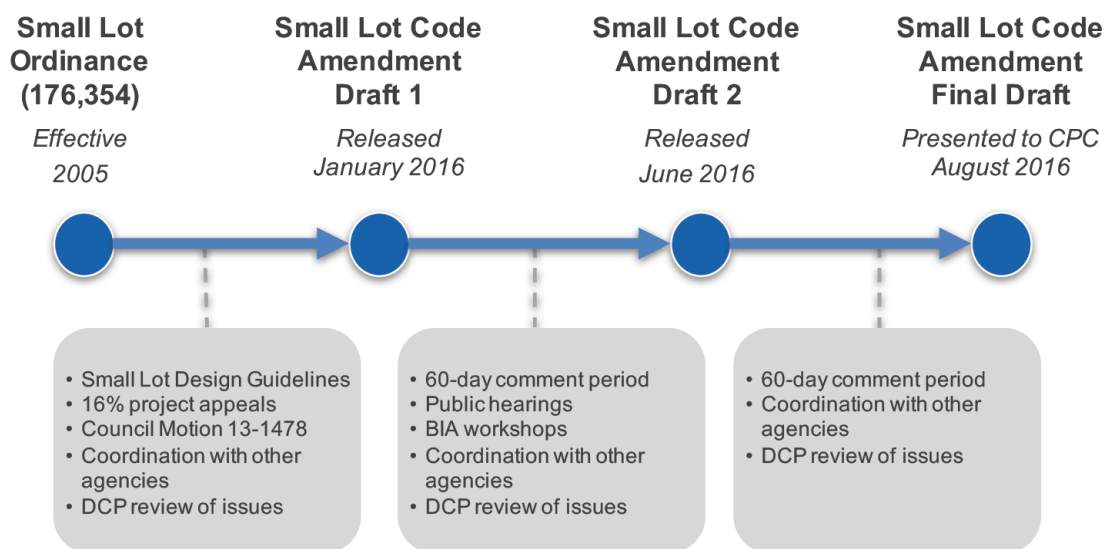

First Round of Public Outreach

In January 2016, a draft of the Small Lot Code Amendment and Policy Update was released to the public for a 60-day public review and comment period. Comments were gathered from public hearings, focus group meetings, and email correspondence.

Small Lot Developers Focus Group

The Department of City Planning hosted two focus group meetings with architects and developers of Small Lot Subdivision projects in July and August of 2015. The meetings were used to garner feedback from the group regarding topics such as the design of access onto the sites, guest parking, landscaping, and design features, such as roofline variation, pedestrian pathways, and façade treatments. The feedback was used to shape the Map and Design Standards.

Public Hearings

The Department of City Planning hosted three public hearings for the Small Lot Subdivision Code Amendment. The first public hearing was on January 20, 2016 at the Felicia Mahood Multipurpose Senior Center in West Los Angeles; the second public hearing was on January 26, 2016 at the Grace E. Simons Lodge in Elysian Park; and the third public hearing was on February 17, 2016 at the Marvin Braude Constituent Services Center in Van Nuys. The public hearings were attended by a total of approximately 200 people.

Second Round of Public Outreach

Following the first round of public outreach, and given the input received from both community members and the development community, the Department of City Planning took additional time to further refine the language of the proposed Ordinance amendments and design standards. Specifically, the Department of City Planning formed a Small Lot Working Group comprised of department managers, subdivision staff, and planning staff to review and clarify the provisions contained in the January 2016 draft documents.

A second draft of the Small Lot Code Amendment and Policy Update was later released in June 2016 for an additional 60-day public comment period. The June 2016 draft includes refinements that are in response to the comments received. Additional comments were received from focus group meetings and email correspondence, which are addressed and/or incorporated in the drafts in Exhibit A-C.

In addition, the Department of City Planning engaged other agencies involved in the Small Lot Subdivision process. Briefings were held with subdivision staff from the Department of Building and Safety and other agencies comprising the Subdivision Committee, planning deputies from the Council offices, and land use attorneys from the City Attorney's Office.

Small Lot Developers Focus Group

The Department of City Planning hosted two additional focus group meetings in May 2016 with architects and developers of Small Lot Subdivision projects to gather further comments on proposed changes.

Email Communications

Staff also received communications by email from close to 200 members of the public, community groups, and neighborhood councils. The communications addressed general support for the update of Ordinance, with recommendations for further refinements. A list of organizations that provided comments is provided after the Summary of Comments.

Summary of Comments

Below is a summary of the major points raised throughout the Council Motion and public outreach process, as well as a list of community groups and neighborhood councils that submitted comments. Other comments submitted were outside the scope of the Small Lot Code Amendment and Policy Update.

Support

Comment: The proposed Small Lot Code Amendment and Policy Update will help to address several issues of prior SLS projects meanwhile still allowing smart growth in multi-family neighborhoods. The need for density and growth in Los Angeles is obvious, and this growth and density should be targeted at infill sites with quality design. Increasing the required perimeter setbacks will make SLS homes more consistent with the surrounding neighborhood, especially when adjacent to single-family homes, and is viewed as essential in maintaining community character and the walkability of our streets. The Ordinance will help to establish basic design regulations for SLS homes, and allow for the preservation of existing bungalow courts. The newly recommended front façade setbacks/articulation for upper levels represents a significant contribution to improved design standards. Comments support the limitation of cantilevered

construction over driveways or open space. The mechanism to require organized trash collection and to remove the impossible placement of a dozen bins on the street for a single property is a much-needed improvement. The adoption of standards that will protect the City's historic bungalow courts and provide a mechanism for individual ownership of these units was supported.

Affordable Housing

Comment: The affordable housing crisis in the City was referenced during the hearings. Participants stated that the City is in need of more affordable housing, and that prior small lot projects have not been covenanted "affordable". The tearing down of affordable housing for luxury housing, especially in established neighborhoods, was a concern. Some speakers stated that as long as small lot projects are allowed to maximize height and density and ignore the prevailing development pattern of their neighbors, developers will be encouraged to destroy more affordable housing. Other comments requested that SLS homes, if rented out, should be rented out at affordable levels in accordance with State law.

Response: The Small Lot Subdivision Ordinance is one tool within the City's toolkit of strategies to boost housing production within the City. Small Lot Projects were not intended to be developed as housing that is required to be "affordable" based on definitions established within State law or in City regulations. They were also not intended to be exclusively luxury housing. However, given that Small Lot Subdivision projects are subject to a different financing and ownership structure compared to a traditional condominium or townhome, Small Lot Homes are comparatively less expensive and therefore more financially attainable than a traditional single family home within the same neighborhood. No Homeowners Associations, or the accompanying fees, are required within Small Lot Projects. In addition, when constructing a Small Lot Subdivision project involves the demolition of rent-stabilized units under the City's Rent Stabilization Ordinance (RSO), the developers are subject to providing relocation assistance and meet the RSO requirements. The Department has no authority to regulate the rental rates of SLS homes. Small Lot Subdivisions must adhere to the height and density requirements of the underlying zone.

Density

Comment: Concerns of density were raised during the hearings, both with regards to Small Lot Subdivisions as well as general citywide housing production. Hearing participants stated that Small Lot Subdivision Projects should abide by underlying zone, or be limited to 3 group dwellings on a single lot, which would provide plenty of space for developers to fit in allowable density. Other comments were to reduce allowed density by lessening the allowed ratio of permitted lots per square-foot, eliminating the half-alley width from density calculations, and including exclusionary provisions deterring short-term rentals such as AirBnB and banning first floor bonus rooms from having an adjoining bathroom. Other comments were to restrict any projects involving SB1818 density bonuses.

Other participants stated that the Small Lot Ordinance actually reduces density because not as many units can fit on a site. Other concerns were raised regarding a denser LA city; the City is over the tipping point for water, air, traffic, parking, etc. in LA, and more development does not equal progress.

Response: Small Lot Projects must adhere to the height and density requirements of the underlying zone. However, because of the spatial complexities to designing these projects to include the units, as well as the required yards and Code-required back-up spaces for driveways, many projects are constructed without maximizing the density, or number of units

that is allowed on the site. Therefore, many Small Lot Projects are well under the permitted density of the underlying zone. Short-term rentals are regulated through a separate City Ordinance, and cannot be addressed through the Small Lot Code Amendment. The State Subdivision Map Act does not authorize the Advisory Agency to regulate the internal programming of the resulting dwelling units. All housing projects within the multi-family zone, when abutting an alley, are allowed to count one-half of the square-footage of the alley for density calculations; this will be maintained for Small Lot Subdivisions for consistency with other existing regulations. Both the State Subdivision Map Act and SB1818 are State-enabled programs, and the City cannot preclude a developer from filing a Small Lot Subdivision Project with a density bonus request.

Further Comment: Other comments requested that the minimum lot width be reduced to 8 feet to encourage narrower units with tandem parking.

Further Response: The proposed minimum lot width of 18 feet is intended to encourage larger habitable spaces at the ground floor in lieu of building additional height. The 18 feet lot width does not preclude tandem parking as SLS homes can still, and are encouraged to, provide habitable spaces at the ground floor, comparable to traditional single-family homes.

Lots Eligible for Small Lot Subdivision

Comment: Other comments were to limit the size of SLS projects to prohibit large subdivisions exceeding 100 SLS homes. Other comments were to restrict where Small Lot Subdivisions are permitted, for instance limiting Small Lot Subdivisions to empty infill lots only, restricting Small Lot Subdivisions from R2 zones. R2 zones were intended as “two-family” dwellings with only two dwelling units on a given lot, and were envisioned as a “transition” zone between single-family and multi-family zoned neighborhoods. Allowing Small Lot Subdivisions in R2 zones lot conflicts with the “two-family” and “transitional” intent of the R2 zone.

Response: Project applicants have the right to lot assembly, and the Department does not have the authority to limit the size of subdivisions. However, the proposed Small Lot Design Standards and Map Standards contains additional provisions to further shape and enhance subdivisions of 20 units or more. The existing SLS Ordinance permits Small Lot Subdivisions on R2 zoned lots only when abutting a commercially- or industrially-zoned lot. Within eleven years of implementation, and of over 300 cases approved, only one Small Lot Subdivision has been approved in the R2 Zone. Small lot subdivisions on R2 zoned lots are subject to the same provisions of the underlying R2 zone. The intent of allowing Small Lot Subdivisions in the R2 zone is to maintain consistency with the underlying zoning code and development rights of other multi-family projects in the same zone.

Setbacks

Comment: Some hearing participants stated that front setbacks in R zones should be mandatory, and not based on prevailing setbacks; other participants stated that fifteen-foot setbacks are excessive for small lot projects. Some comments requested that required side yard setbacks be increased to 15 feet when abutting existing single-family residences. The Ordinance should include statement that the provision front yard setback is a clarification of existing law (underlying zoning) because current ordinance says nothing about front yard setbacks. There should be no reductions for side setbacks: 5 feet is insufficient for trees and fire access. There should be no reductions for rear yard setbacks. The RD and R2 Zones should be added to the list of zones that require abutting projects to provide a 15-foot setback.

Response: The Code Amendment changes the existing yard requirements for Small Lot Subdivision Projects is in direct response to the comments received during the public

participation process. With the Code Amendment, the front yard of the underlying zone shall apply to the front lot line of the perimeter of the subdivision, and a 10 foot rear yard shall be required along the Rear Lot Line of the perimeter of the subdivision. Subdivisions abutting any single family zone shall provide larger setbacks within side and rear yards per the underlying zone. This will introduce more open spaces throughout the projects especially along the perimeter of the subdivision that abuts the street or neighboring lots. The intent is to ensure consistency with the multi-family development potential of surrounding lots, meanwhile allowing more sensitivity to adjacent single-family zones.

Stepbacks and Roof Decks

Comment: Some hearing participants requested that upper level step backs be codified and mandatory on the third and fourth levels. The open deck requirement should apply to each unit, not just one for every 2 units, or the neighbor on one side gets stuck with a sheer wall.

Response: Because of the spatial complexities to designing Small Lot Projects to include the units, as well as the required yards and Code-required back-up spaces for driveways, the January 2016 draft required upper-level step backs for only those Small Lot units that face a public street. The draft required all street-fronting units to provide either a pitched roof or an open deck.

Further Comment: Some developers stated that the requirement of either a pitched roof or open deck was too cumbersome and limited opportunities for creativity in architectural design.

Further Response: The Design Standards were further modified to establish a larger menu of options to achieve the intent of stepping upper floors back to reduce overall massing. The revised draft requires that Small Lot Homes fronting a public or private street must articulate the roofline by incorporating either a sloped roof, an open deck, a modulated roof, or any other form of roofline modulation.

Driveways/Parking/Orientation

Comment: Hearing participants stated that parking should not be allowed on the ground floor facing the street. A front yard and family room are necessary for “eyes on the street” surveillance. Some participants requested that guest parking be provided at a ratio of a quarter space per lot, while other participants requested that guest parking requirements be eliminated altogether.

Response: Parking is not allowed within the required front yard of Small Lot units that face a public street. While guest parking was not required previously, new Map Standards will require that Small Lot projects with eight or more units provide a quarter guest parking space per unit.

Further Comment: Some comments requested that 2 guest parking spaces be required for every 4 small lot homes. Some developers asked for further clarification on required driveway widths and the location of guest parking. Some comments requested that small lot driveways cannot be named as streets. Other comments requested that all access driveways be 20 feet clear to sky regardless of project size, and that overhangs be limited to 2 feet maximum to minimize the top-heavy look of small lot homes.

Further Response: The Map Standards require guest vehicular parking for small lot subdivisions containing 8 or more newly constructed dwelling units, at a ratio of 0.25 spaces per unit, which are beyond the requirements for a typical single-family home. Requiring guest parking for small lot subdivisions of 4 or fewer homes will cause additional lot configuration challenges. The Map

Standards clarify that common access driveways must meet the back-up requirements per LADBS provisions, and that a minimum 10 foot width must remain open to sky along upper levels. Guest parking must be located within the subdivision and can be located within required yards provided it does not obstruct required pathways. The Department of City Planning does not have the authority to regulate the naming of Common Access Easements or driveways within Small Lot Subdivisions.

Americans with Disabilities Act Compliance and Small Lot Subdivisions

Comment: Some hearing participants stated that Small Lot units should be required to comply with the Americans with Disabilities Act. The current model of placing parking garages on the first floor and living spaces above makes it difficult for those with disabilities to live in one of these homes. The Ordinance is an opportunity to meet the challenges of prioritizing housing for an aging population per Mayor Garcetti's Purposeful Aging LA initiative and the Fair Housing Act. Fair Housing Act units must have at least one accessible entrance; accessible common use areas; doorways and a route through the dwelling wide enough for wheelchairs to pass; switches and controls placed within reach; and bathrooms and kitchens usable in a wheelchair.

Response: As a hybrid housing typology, Small Lot Subdivisions are considered single-family homes based on the Building Code. Therefore, similar to traditional single-family homes, Small Lot Homes are not subject to ADA requirements.

Bungalow Court Small Lots

Comment: Hearing participants stated that the City should encourage preserving existing bungalow courts and converting them into small lots. Bungalow courts should be allowed more flexibility by adding square footage or reducing the 75% roof coverage requirement to allow for additional living spaces. A 500 square-foot bungalow would be much more livable if it were 200-300 square-feet larger. The City should develop a reasonable formula to allow additional square footage. The City should make it possible for projects with 4 or fewer parcels to make use of the proposed adaptive reuse component of the revisions.

Response: The intent of adding the Bungalow Court Small Lot provisions to the Small Lot Subdivision Ordinance was to preserve this specific typology. The January 2016 draft established that allowing additional square footage to be added to the structures would potentially undermine the intent to preserve these units. In addition, any expansion of these units would trigger current Building Code requirements, which, again, go against the original intent of adding these provisions to the Ordinance. Based on comments received, the threshold for a qualifying project was amended to four units from five units.

Further Comment: Some comments were raised regarding the limitations on additional square footage to existing bungalow courts. Developers stated that in order to make the bungalow courts more functional and livable, some additions are necessary to ensure quality living spaces. Other comments requested that SLS homes not be allowed to replace existing courtyards or landscaped courtyards in bungalow courts. Other comments were raised regarding how parking and setbacks are regulated for bungalow courts as grandfathered structures generally allow non-conforming building rights per the Municipal Code. Small Lot Subdivisions on infill sites should not be required to provide streetscape improvements or roadway widenings.

Further Response: The Code Amendment was further revised so that existing bungalow courts may be maintained, repaired, or structurally altered provided it conforms with LAMC Section 12.23 A ("Nonconforming Buildings and Uses"). While the goal is to preserve these existing structures, the intent was to allow some flexibility so that they can become more livable homes,

meanwhile maintaining consistency with other regulations for nonconforming uses. Applicants converting bungalow courts into SLS homes are encouraged to preserve common open space areas. Sites that are eligible for historic designation must consult with the Office of Historic Resources to verify the development potential of existing bungalow courts. In addition, any newly construction dwelling units within existing bungalow courts are subject to the same requirements as typical small lots. Street dedications and improvements regulated by the Bureau of Engineering, and are not under the authority of the Department of City Planning.

Neighborhood Character

Comment: Hearing participants stated that the designs of new projects should be consistent with character of neighborhood and compatible with adjacent projects and buildings. The current small lot projects are built so that a 30 foot wall towers over adjacent homes. While small lots are only permitted in multi-family or commercial zones, developers are proposing Small Lot Subdivisions in neighborhoods that are predominantly built out as single-family; therefore some Small Lot projects are out of context.

Developers do not need an incentive to build in Los Angeles. Incentives are unnecessary for Small Lot Subdivisions since developers would prefer to build and sell, rather than deal with rental and leasing complications, and therefore would not opt out of Small Lot Subdivisions if the incentives are eliminated. Small lots should not be used to replace existing homes, especially existing affordable rental homes. Developers should not be allowed to assemble multiple properties and request zone changes to create mega subdivisions as this conflicts with the intent of zoning regulations. In addition, developers are allowed to side-step environmental laws by completing inaccurate Master Applications, thereby getting a mitigated negative declaration.

Response: The existing SLS Ordinance allows reduced front, rear and side yards, reduced passageways, and exemptions from open space and guest parking regulations required of all multi-family and condominium projects, respectively. Given the difficulty of fitting multiple small lot units within one infill parcel, Small Lot Subdivisions are often designed in a “row home” style and the number of units proposed is below the full density allowed on the site. In addition, many projects are new investments in areas zoned for multi-family development that have not seen new development within the vicinity and previously underdeveloped with single-family homes or duplexes. The new Code Amendment and Small Lot Design Standards seek to address the design of these projects, to allow architectural freedom within reasonable boundaries to respect yard requirements and provide roofline modulation and façade relief.

The intent of the Small Lot Subdivision Ordinance was to facilitate infill development on underutilized parcels. Often times, Small Lot Projects are built within neighborhoods that are zoned for multi-family uses, but have not seen development over the past five decades. Applications are only approved when a project has gone through the public process and the appropriate findings can be made. The City makes a determination on what type of environmental clearance would be appropriate for a Small Lot Project. Some Small Lot Projects can qualify for Categorical Exemptions from environmental review that is established with the State CEQA Guidelines and the City’s CEQA Thresholds.

Further Comment: Enforcing specific design standards are too restrictive and cumbersome for applicants and developers, and will force “cookie-cutter” Small Lot Subdivisions in future projects. Other comments requested that SLS homes be subject to the roofline encroachment plane and side wall articulation requirements of the draft Baseline Mansionization Ordinance (BMO).

Further Response: The Design Standards were clarified to emphasize the intent over specific architectural features. Furthermore, several design standards have been consolidated into a

“menu” of options, in which applicants must choose a select number from an established menu of design alternatives to implement. This allows flexibility within the framework of design provisions, and ensures that all Small Lot Subdivisions will meet the bare minimums of design requirements while still allowing flexibility for architectural creativity and innovation. The BMO only applies to single-family zones, and is not applicable to the multi-family zoned lots in which SLS projects may be developed.

Design Standards – Enforceability

Comment: Some hearing participants stated that a need for codified Design Standards, a Design Review Board, and overall need for projects to respect neighbors. Other comments were to require strict conformance with the existing 2014 Small Lot Design Guidelines. Others requested that the design standards not be governed through a Design Review Board. The design standards must be mandatory for all projects, and the ordinance must be fully enforceable with no extra benefits or “discretionary” add-ons for developers. The new standards are good, but more thought should be put into design standards and setbacks that might mitigate or prevent existing residents from the impacts of new developments. The City needs to be mindful of how this affects cases already in the process – It should be enforceable as soon as possible, and should apply to not-yet started projects that in the pipeline. The City needs to clarify what will happen to the existing guidelines and if they will still be used. The City should clarify which part of the State Map Act allows the guidelines enforceable and address why the Map Act forbids guidelines when many nearby cities effectively use them to maintain design consistency.

Response: The Small Lot Design Guidelines were released in 2014 as recommendations and “best practices” for Small Lot Subdivisions. They were not written as enforceable standards. However, the Department of City Planning is proposing to translate select Design Guidelines into new enforceable Design Standards. The Design Standards will codify functional design components for all small lot projects, including dwelling orientation, entryways, façade articulation, roofline and roof decks, building modulation, pedestrian pathways, fences and walls, landscaping, common open space areas, and amenities.

The remaining guidelines that were not translated into standards will be included in a best practices and recommendations document that will be prepared by the City subsequent to the adoption of the Code Amendment. Because the Ordinance is citywide in scope, having a Design Review Board to govern the design of projects Citywide would be impractical, undesirable, and only result in “cookie-cutter” subdivisions citywide. The Design Standards that will be adopted will be enforceable through the administrative clearance established by the Small Lot Code Amendment process. In addition, the City cannot require that projects that were filed prior to the effective date of the ordinance meet the new regulations, as many projects are filed as Vesting Tentative Tract Maps and retain their vested rights from the date the project is deemed complete. Similar to any residential project, Small Lot Subdivision projects may request adjustments as allowed by the Zoning Code.

Height

Comment: Hearing participants requested that the height of projects should not to exceed the existing highest multi-family dwellings in neighborhood. Many previous projects have resulted in 30-foot tall towers in otherwise single-story or two-story neighborhoods. No height variances should be granted. Height and density of these project are not reduced enough. There was both support and opposition for the allowance of roof decks. Some hearing participants requested that rooftop decks be banned from small lot subdivisions as they cause privacy issues with abutting neighbors.

Response: Small Lot Projects must adhere to the height and density requirements of the underlying zone. Roof decks are an allowed use for projects within multi-family zones, and from time to time, projects within Height District 1XL, which typically has a 30-foot height restriction, request a height adjustment to include roof railings as part of their projects. These requests are discretionary, and the decision maker is required to make the findings necessary to justify such a request. The Design Standards also require that, if provided, rooftop decks be oriented internally to the subdivision and be stepped back and screened from abutting neighbors.

Landscaping, Trash, and Maintenance

Comment: Hearing participants requested that landscaping be required in the side yards, and landscape plans should be required for all projects. Existing trees should be saved. All trash bins and containers should be out of sight. The Code Amendment should require consolidation of trash collection and bins.

Response: The Small Lot Design Standards will require that all open areas not used for buildings, parking areas, driveways, pedestrian pathways, utilities, etc, be attractively landscaped and maintained. Through the Subdivision process, projects are required to provide a tree report and replace trees based on City regulations. With regards to trash, all projects will be required to provide on-site trash pick up in accordance with the Map Standards, whether by individual cans that are stored within garages, or through a consolidated trash bin that is screened from public view. Trash storage and collection will not be permitted on public streets.

Further Comment: Comments requested that small lot subdivisions must provide Covenants, Conditions, and Restrictions (CC&Rs) that require a governing body or Homeowners Association to ensure proper maintenance of the property. Other comments requested that required open space remain open to sky in perpetuity, and that required open space be separate and distinct from areas used for above-ground utilities, transformers, trash enclosures, driveways, and parking spaces.

Further Response: Prior small lot subdivisions have recorded maintenance associations that ensure proper maintenance of the property. The Map Standards will require a Maintenance Agreement for all small lot subdivisions that will ensure maintenance of all common areas and shared facilities, such as trees, landscaping, trash, parking, community driveways, and walkways. The Map Standards will require Common Access Driveways and Walkways that must be open to sky. The Map Standards will also require a Common Open Space Easement for all small lot subdivisions of 20 or more units, and must be designed in accordance to the common open space provisions of the Design Standards. The common open space areas shall be designed to be multi-functional and accommodate a range of passive, active, or social uses, with enhancements such as landscaping, activity lawns, picnic pavilions, bench seating, etc. In addition, per the Ordinance, the lot area coverage by all structures shall not exceed 75% of the approved small lot, meaning that the remaining 25% of the small lot shall be open to sky.

Sustainability

Comment: Hearing participants requested that any new buildings need to capture water on site and become neutral. All projects should be required to install solar panels, since reserving space for solar panels is not enough anymore. The push towards densification is extremely short-sighted in light of the water infrastructure being extremely outdated and dilapidated. Densification is good for the tax base, but not good in any other regard.

Response: Small Lot Projects are encouraged to incorporate solar elements and are required to comply with the applicable building codes pertaining to solar panels. They are also required to

comply with the City's Low Impact Development (LID) Ordinance requirements. The City's growth strategy as identified in the City's General Plan is to direct density near transit and urban areas. The Small Lot Ordinance is intended to promote infill development in established urban areas where the zoning already allows for the number of units proposed and has adequate infrastructure in existence.

Notifications/Process

Comment: Hearing participants stated that there should be a provision for notifying public of changes/updates to the Design and Map Standards – they cannot simply be internal policy documents. The entitlement process should be slowed down to allow for more opportunities to gather input. Neighborhood Councils need time to respond to citywide amendments.

Response: The Department of City Planning implemented and exceeded its standard public participation policy for the update of the Small Lot Ordinance. This included inclusion of the project within the Early Notification System to all Certified Neighborhood Councils and interested parties, three public hearings, and inclusion of comments received by email in shaping the proposal. In addition, the typical 60-day public review period was extended to two separate rounds of 60-day public review periods in order to allow additional time for comments.

Further Comment: Comments requested that the approval of small lot subdivisions not be administrative, as these developments often change the scale and character of neighborhoods. Those affected by such projects should be involved in the approval process for project proposals.

Further Response: The State Subdivision Map Act establishes a discretionary review process for all tract and parcel map applications. The construction of individual homes on the resulting lots is a by-right process. The proposed Ordinance and Design Standards are intended to update existing regulations to ensure small lot projects will be more sensitive and compatible with the existing neighborhood context and zoning.

Hillside

Comment: Hearing participants stated that these types of developments should not be allowed on hillsides at all, and that the Code Amendment should address the unique characteristics of hillside neighborhoods. Also, the setbacks and shared spaces proposed for hillside communities are not sufficient to protect residents and meet current requirements such as red flag days and fire truck access.

Response: The existing hillside regulations that currently apply to Small Lot Subdivision projects will continue to govern the projects with the Code Amendment. Any Small Lot Project is required to follow regulatory compliance measures regarding construction, which address procedures during red flag days and emergency access.

Street Widening

Comment: Some comments requested that incremental street widening be not required on any infill small lot subdivision projects.

Response: Street widening has been required for small lot subdivisions in the past. Public right-of-way improvements are governed by the Bureau of Engineering.

Small Lot Projects with Zone Changes and Plan Amendments

Comment: Hearing participants stated that zone changes and general plan amendments should not be allowed with Small Lot Projects.

Response: Small Lot Projects were intended as infill development projects within areas where the underlying zoning's land use, height, and density requirements could be met. From time to time, general plan amendments are initiated by the City projects and/or developers request zone changes in order to accomplish the project. These requests accompany proposed Small Lot Projects only a fraction of the time and are discretionary entitlements that are only approved when the appropriate findings can be established.

Participation from Neighborhood Council and Community Groups:

The following Certified Neighborhood Councils formally submitted comments regarding the update of the Small Lot Subdivision Ordinance:

Bel Air Beverly Crest Neighborhood Council
East Hollywood Neighborhood Council
Greater Wilshire Neighborhood Council
Mid City West Community Council
Northwest San Pedro Neighborhood Council
PICO Neighborhood Council
Silver Lake Neighborhood Council
West Hills Neighborhood Council
Westside Neighborhood Council
Woodland Hills Warner Center Neighborhood Council

The following groups formally submitted comments regarding the update of the Small Lot Subdivision Ordinance:

Building Industry Association of Southern California
Echo Park Improvement Association
Friends of Studio City
Friends of Valley Village
La Brea Willoughby Coalition
South Hollywood Neighborhood Association
St Andrews Square Neighborhood Association
West Adams Heritage Association
West of Westwood HOA
Westwood South of Santa Monica Blvd HOA

EXHIBIT A
REVISED DRAFT
SMALL LOT ORDINANCE

ORDINANCE NO. _____

A proposed ordinance amending Section 12.22 C.27 (Small Lot Ordinance), Chapter 1 of the Los Angeles Municipal Code to require greater front and rear yard setbacks, create a division of land process for “bungalow courts” small lot projects, and establish design standards for small lot subdivision projects with an incidental administrative clearance process.

**THE PEOPLE OF THE CITY OF LOS ANGELES
DO ORDAIN AS FOLLOWS:**

Section 1. Subdivision 27 of Subsection C of Section 12.22 of the Los Angeles Municipal Code is amended to read:

27. **Small Lot Subdivision.** The purpose of this provision is to create alternative fee-simple home ownership within the multifamily and commercial zones. A Small Lot Subdivision shall be permitted in the R2, RD, R3, R4, R5, RAS and the P and C zones pursuant to an approved subdivision-tract map or parcel map. A subdivision for the purposes of small lots enables the construction of new small lot homes and provides opportunities for the preservation of multiple older detached dwellings or clusters of dwellings (bungalow courts) located on a single lot to be rehabilitated as for-sale dwellings on individual small lots.

(a) Construction of New Small Lots. Notwithstanding any provisions of this Code relating to minimum lot area to the contrary, in the R2, RD, R3, R4, R5, RAS and the P and C zones, parcels of land may be subdivided into lots which may contain one, two or three dwelling units, provided that the density of the subdivision complies with the minimum lot area per dwelling unit requirement established for each zone, or in the case of a P zone, the density of the subdivision shall comply with the minimum lot area per dwelling unit of the least restrictive abutting commercial or multi-family residential zone(s).

(1) (a) A parcel map or tract map, pursuant to Section 17.00 et seq. of this Code, shall be required for the creation of a small lot subdivision. The parcel map or vesting tentative tract map must comply with the Advisory Agency Small Lot Map Standards; and

(b) —

(2) For small lot subdivision projects, no demolition, grading, building permit or certificate of occupancy shall be issued unless the Director of Planning has reviewed the application and determined, by signature, that the Small Lot Subdivision Project complies with all applicable City Planning Commission Small Lot Design Standards. The Director of Planning sign-off is an Administrative Clearance that is ministerial in nature.

(i) The Director is authorized to designate one or more members of the professional staff of the Department of City Planning to perform any of the Director’s duties of this section. The Director shall establish an administrative process, guidelines, procedures, requirements, and forms as may be necessary to conduct the review of the Administrative Clearance to determine conformance with the Small Lot Design Standards.

- (ii) The application for the Administrative Clearance shall be filed concurrent with the tract or parcel map.
- (iii) All small lot subdivisions shall be conditioned to require conformance with the Director of Planning approved plans.
- (3) The minimum lot width shall be 4618 feet and the minimum lot area shall be 600 square feet. The Advisory Agency shall designate the location of front yards in the subdivision tract or parcel map approval.
- (c) ~~Vehicular access may~~ Access shall be provided to either a lot containing a dwelling unit ~~and~~ to its required parking spaces, pursuant to Section 12.21 A.4(a) by way of a public or private street ~~or, an alley frontage, driveway, or an access or similar access to a street.~~ easement.
- (d) ~~All~~(5) The lot area coverage by all structures on a lot which includes one or more dwelling units, may, taken together, occupy no more than 80% of the lot area shall not exceed 75% of an approved small lot, unless the tract or parcel map provides ~~common~~ an open space easement equivalent to 2025% of the lot area of each lot not meeting this provision.
- (e)
- (6) No front, side, or rear yard shall be required between ~~lots interior lot lines created~~ within an approved small lot subdivision. ~~However, a five-foot setback shall be provided where a lot abuts a lot that is not created pursuant~~
- (7) The provisions of the front yard of the underlying zone shall apply to ~~this~~ the Front Lot Line of the perimeter of the subdivision.
- (f)(8) The following shall apply to the perimeter of the subdivision:
- (i) Along the perimeter of the subdivision abutting any R1 or more restrictive single family zone, the provisions of the side yard and rear yard of the underlying zone shall apply; and
- (ii) Along the perimeter of the subdivision not abutting any R1 or more restrictive single family zone the following shall apply:
- a. A five-foot yard shall be required along the Side Lot Line of the perimeter of the subdivision; and
- b. A ten-foot yard shall be required along Rear Lot Line of the perimeter of the subdivision.
- (iii) Along the perimeter of the subdivision abutting an alley, half the alley width may be counted towards the rear yard requirements per 12.22 C.10.
- (9) No passageway pursuant to Section 12.21 C.2- of this Code shall be required.

- ~~(g)~~ 10 In a P zone, lots may be developed as a small lot subdivision, provided that the General Plan land use designation of the lot is "commercial" or "multiple family residential."
- ~~(h)~~ 11 In an R2 zone, a lot may be developed as a small lot subdivision provided that the lot meets the requirements of Section 12.09 A.3~~7~~ of the Code.
- ~~(i)~~ 12 A dwelling unit in a small lot subdivision shall not be required to comply with Paragraphs (a), (b), (f) and (g) of Section 12.21 A.17~~7~~ of this Code.
- ~~(j)~~ 13 Fences and walls within five feet of the front lot line shall be no more than three and one-half feet in height~~7~~; in accordance with Section 12.22 C.20 of this Code. Fences and walls within five feet of the ~~side~~Side and ~~rear lot lines~~Rear Lot Line of the subdivision shall be no more than six feet in height.
- (14) All small lot subdivisions are exempt from the "frontage" requirement as defined in the definition of "Lot" pursuant to Section 12.03. Frontage requirement as defined in the definition of "Lot" pursuant to Section 12.03 shall be waived for all lots created within a small lot subdivision

(b) "Bungalow Court" Small Lots. Existing bungalow courts with four or more older detached dwellings oriented around a common landscaped courtyard on a single lot with a Certificate of Occupancy issued prior to 1950 may be subdivided into small lots and shall comply with Subparagraphs (1), (2) (4), and (9) through (14) of this Subdivision.

- (1) Notwithstanding any provisions of this Code relating to minimum lot area to the contrary, in the R2, RD, R3, R4, R5, RAS and the P and C zones, parcels of land may be subdivided into lots which may contain one, two or three dwelling units, provided that the density of the subdivision complies with the minimum lot area per dwelling unit requirement established for each zone, or in the case of a P zone, the density of the subdivision shall comply with the minimum lot area per dwelling unit of the least restrictive abutting commercial or multi-family residential zone(s). Bungalow courts that are nonconforming as to density, yards, or parking may be subdivided provided that the subdivision does not further increase the density nor reduce the yards, and that existing parking be maintained, respectively.
- (2) A nonconforming building, structure, or improvements may be maintained or repaired or structurally altered provided it conforms with Section 12.23 A of this Code. However, the existing structure shall also be in conformance with the "Bungalow Court" Small Lot Design Standards.
- (3) All existing dwellings shall provide parking as required on the original permits. No additional parking is required.
- ~~(4)~~(4) All new dwellings added to the Bungalow Court Small Lot project are subject to Subparagraphs (1) through (13) of this Subdivision including current setback requirements, parking, and applicable Small Lot Design Standards.

EXHIBIT B
REVISED DRAFT
SMALL LOT DESIGN STANDARDS

SMALL LOT SUBDIVISION

CODE AMENDMENT AND POLICY UPDATE

DRAFT DESIGN STANDARDS – REVISED August 11, 2016



In accordance with LAMC § 12.22 C.27(a)(2), all new applications for Small Lot Subdivisions are required to file an Administrative Clearance through which they must demonstrate compliance with the following Design Standards.

A. Building Design

1. Dwelling Orientation.

- a. Small Lot Homes abutting a public right-of-way or private street shall orient the primary entryway ("front door") toward the street or, where there is a physical site constraint, shall provide a clearly identifiable entry to the site from the street.
- b. Small Lot Homes located in the "interior" of the subdivision shall orient the primary entryway toward and visible from a pedestrian pathway that is connected to the public right-of-way or private street.
- c. Small Lot Homes that abut an alley shall orient the primary entryway toward the alley or shall be connected to a pedestrian pathway that leads directly to a public or private street.

2. Primary Entryways.

All Small Lot Homes shall have a primary entryway. All primary entryways shall provide the address or unit identification, ornamental low-level lighting for illuminating the entry area, a landing area with enhanced paving material, different texture, or color, and incorporate at least three of the following elements:

- a. The door shall be recessed from the building façade.
- b. The doorway shall be designed with an overhead projection such as an awning, and/or other architectural design features so as to distinguish the front door from the rest of the building façade.
- c. Entryway shall be raised or sunken at a minimum of 10 inches, with a minimum of two steps, from the pedestrian pathway to the landing area.
- d. Entryway shall be clearly marked with a side window panel, adjacent window, or a door with a window.
- e. Entryway shall be recessed at least 2' from the building façade.

3. Primary Entryways Between Small Lot Homes.

Small Lot Homes shall provide at least a 10' separation between those portions of the Small Lot Homes from the pedestrian pathway to the primary entryway.

SMALL LOT SUBDIVISION

CODE AMENDMENT AND POLICY UPDATE

DRAFT DESIGN STANDARDS – REVISED August 11, 2016



4. Façade Articulation.

All façades facing a public right-of-way, private street, or project perimeter, and all exterior building elevations located greater than 7 feet from an adjacent Small Lot Home facade shall be treated with an equal level of details and articulation and shall incorporate at least two of the following building articulation techniques:

- a. Varied windows treatment such as multi-pane, green house, bay, or block framed windows. Aluminum framed windows or doors that are flush with the plane of the building shall not be included as a change in material or break in the plane.
- b. Porticos, awnings, terraces, balconies or trellises.
- c. Change in exterior building materials such as stucco to one of the following: wood, glass, brick, metal spandrel, cement board siding, or tile.
- d. A break in façade plane of a minimum of 6 inches in depth.
- e. The floor with the primary entrance and floors below shall be architecturally enhanced from the floors above so as to create human scale to the buildings.

5. Varied Roofline.

For any Small Lot Home façade fronting a public or private street exceeding two stories in height, the roofline shall be articulated by incorporating one of the following:

- a. A roof with a slope equal or greater to 2 inches to 12 inches, including but not limited to a sloped or curved roofline at the top of the dwelling.
- b. An open deck, with a minimum of 6 feet in depth.
- c. A flat roof with a minimum of 2 feet vertical height difference for a minimum of 10 horizontal feet along the roofline of each building façade.
- d. A break in façade plane of a minimum of 6 inches.
- e. Any form of roofline modulation such as a step back, an outdoor stairwell, or a corner balcony.

6. Roof Decks.

All roof decks not facing a public right-of-way or private street shall be oriented internally to the Subdivision, and be stepped back and screened from abutting neighbors.

7. Building Modulation.

For a Small Lot Subdivision containing more than six Small Lot Homes in a single row, the following shall apply:

- a. A lateral shift of a minimum of 6 inches for every three units.
- b. A building separation of a minimum of 6 feet for every six units.
- c. Small Lot Homes shall be unique in design, and shall not be a repetition of the adjacent buildings. There shall be at least three variations within each stand-alone dwelling or cluster of dwellings, such as changes in color or material, fenestration, roof articulation, balconies, façade setbacks, etc.

SMALL LOT SUBDIVISION

CODE AMENDMENT AND POLICY UPDATE

DRAFT DESIGN STANDARDS – REVISED August 11, 2016



B. Pedestrian Connectivity and Access

1. Pedestrian Pathways.

Pedestrian pathways of a minimum width of 3 feet shall be provided from the public rights-of-way to all primary entryways and common areas, such as centralized trash enclosures, guest parking, and open space easements.

A pedestrian pathway located within or parallel to a Common Access Driveway shall be constructed and/or treated with paving that distinguishes the pathway from vehicular traffic.

2. Fences/Walls.

All fences or walls shall be decorative such as latticework, ornamental fences, screen walls, hedges or thick growths of shrubs or trees with the intention to avoid solid masonry walls along the street and adjacent to the open space areas.

Fences or walls separating a subdivision from a street provided in the front yard shall provide a point of entry into each lot abutting the street.

C. Landscaping, Common Open Space Areas, and Amenities

1. All open areas not used for buildings, parking areas, driveway, pedestrian pathways, utilities, or common open space areas shall be attractively landscaped and maintained.
2. Any common open space areas shall be located at grade level, contiguous, and readily accessible to all residents. Common open space areas shall be multi-functional and designed to accommodate a range of passive, active, or social uses, with enhancements such as landscaping, activity lawns, picnic pavilion, bench seating, decorative bike racks, dog washing station, retaining or planting mature trees, central mailboxes, and/or children's play areas.
3. All yards of a subdivision abutting the street shall be improved with amenities, such as landscaping, decorative fencing, uncovered patios, seating areas, pedestrian pathways, garden walls, and/or decorative bike racks.

SMALL LOT SUBDIVISION

CODE AMENDMENT AND POLICY UPDATE

DRAFT DESIGN STANDARDS – REVISED August 11, 2016



D. Mixed Use Small Lots

Small Lot Subdivisions may provide Small Lot Homes that contain commercial uses at the ground floor (“Mixed Use Small Lot Homes”). Mixed Use Small Lots must comply with all other applicable regulations governing the site with regards to parking, signage, access, and FAR limitations in the LAMC. The following Design Standards shall be required for any Mixed Use Small Lot Home *in addition* to the other Design Standards contained in this document.

1. Building Orientation and Entry.

- a. A separate, Ground Floor entrance to the commercial component, or a lobby that serves both the residential and Commercial Uses components shall be provided.
- b. A pedestrian entrance to the Commercial Uses component that is directly accessible from a public street, and that is open during the normal business hours posted by the business shall be provided.
- c. A mixed use Small Lot Home shall be located along the perimeter of the subdivision abutting the street.

2. Building Design.

A Mixed Use Small Lot Home shall be designed with an identifiable ground floor commercial component.

- a. Store entrances shall be recessed, not flush, with the edge of the building facade to articulate the storefront and provide shelter for persons entering and exiting.
- b. The ground floor commercial use shall be separated from upper residential floors, with a façade treatment such as an awning, framing, or setback overhang of at least 18” in depth, so as to distinguish a visual commercial base for the building.
- c. The exterior walls and doors of a ground floor containing non-residential uses that front adjacent streets shall consist of at least fifty percent transparent windows, unless otherwise prohibited by law.

SMALL LOT SUBDIVISION

CODE AMENDMENT AND POLICY UPDATE

DRAFT DESIGN STANDARDS – REVISED August 11, 2016



E. Bungalow Courts

Existing bungalow courts with a common landscaped courtyard may be subdivided into small lots (“Bungalow Court Small Lots”) in accordance with the Small Lot Code Amendment. Existing “Bungalow Courts” converting into a Small Lot project shall only be required to comply with the following Design Standards.

1. Common Access Driveway.

Existing Common Access Driveways, pedestrian pathways, and central common open space areas shall be maintained.

2. Pedestrian Pathway.

Pedestrian pathways of a minimum width of 3 feet shall be provided from the public rights-of-way to all primary entryways and common areas, such as centralized trash enclosures, guest parking, and open space easements.

3. Existing Structures.

New dwelling construction or additions to a designated or identified Historic structure shall be in conformance with the Secretary of the Interior’s Standards.

4. New Dwelling.

All new dwellings added to the Bungalow Court project shall meet the applicable design standards in sections A, B, and C of the Small Lot Design Standards.

5. Landscaping.

All open areas not used for buildings, parking areas, driveway, pedestrian pathways, utilities, or amenity areas shall be attractively landscaped and maintained.

Draft Small Lot Design Standards Illustrations

2. Primary Entryways, All Small Lot Homes shall have a primary entryway. All primary entryways shall provide the address or unit identification, ornamental low-level lighting for illuminating the entry area, a landing area with enhanced paving material, different texture, or color, and incorporate at least three of the following elements:

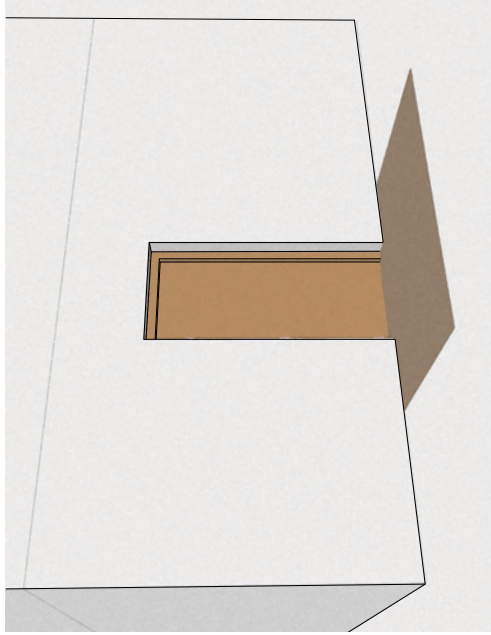

a. The door shall be recessed from the building facade.

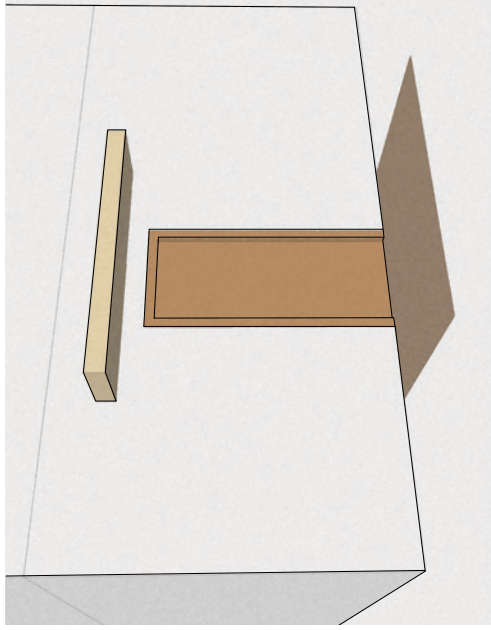

b. The doorway shall be designed with an overhead projection such as awning.

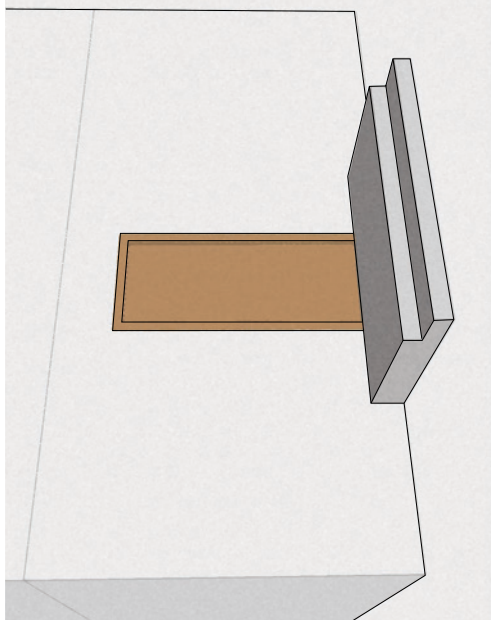

c. Entryway shall be raised or sunken at a minimum of 10 inches from the pedestrian pathway to the landing area.

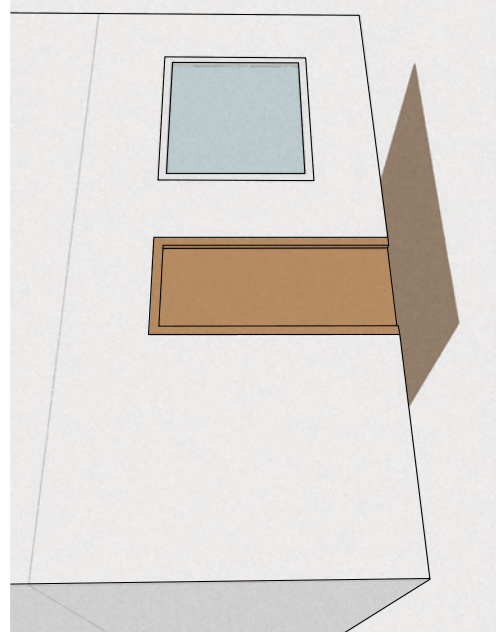

d. Entryway shall be clearly marked with a side window.

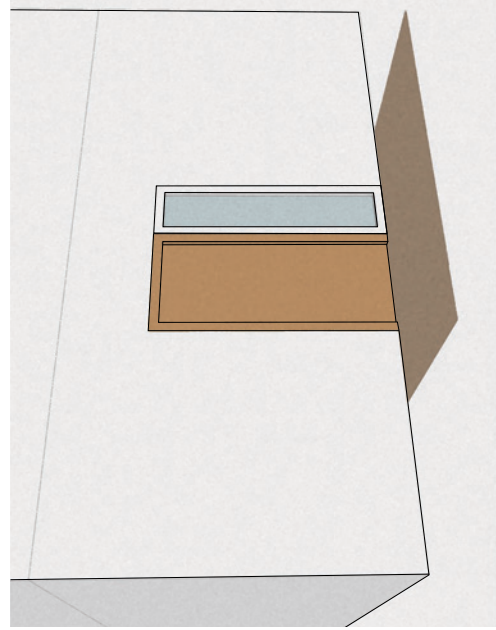

d. Entryway shall be clearly marked with a side window.

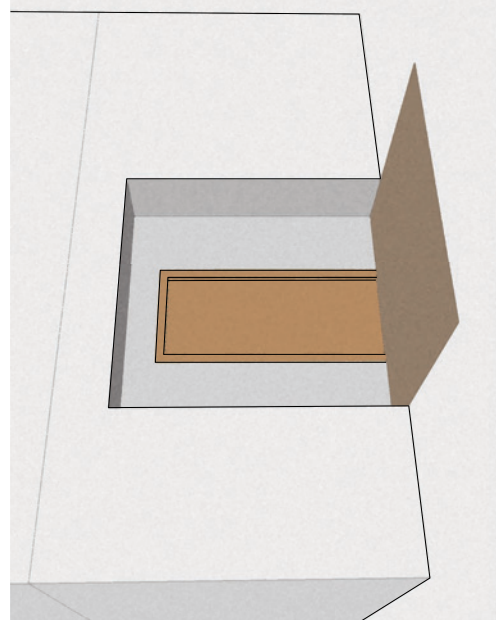

e. Entryway shall be recessed at least 2' from the pedestrian pathway to the landing area.

Draft Small Lot Design Standards Illustrations

3. Primary Entryways between Small Lot Homes, Small Lot Homes shall provide at least a 10' separation between those portions of the Small Lot Homes from the pedestrian pathway to the primary entryway.



Existing

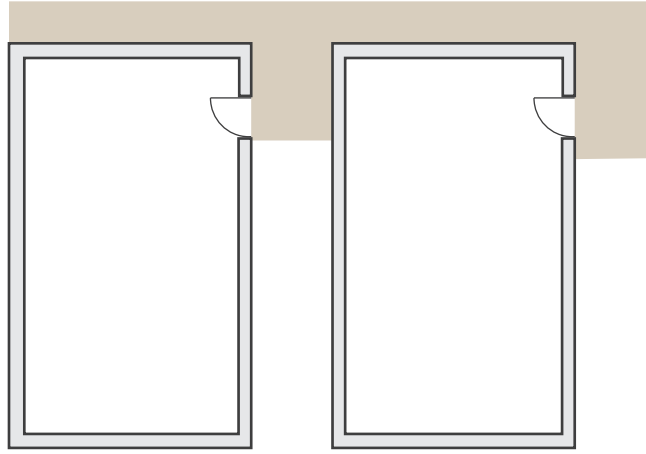

Proposed Design Standards

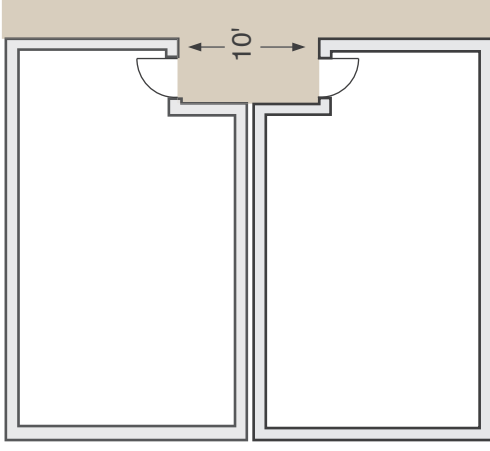
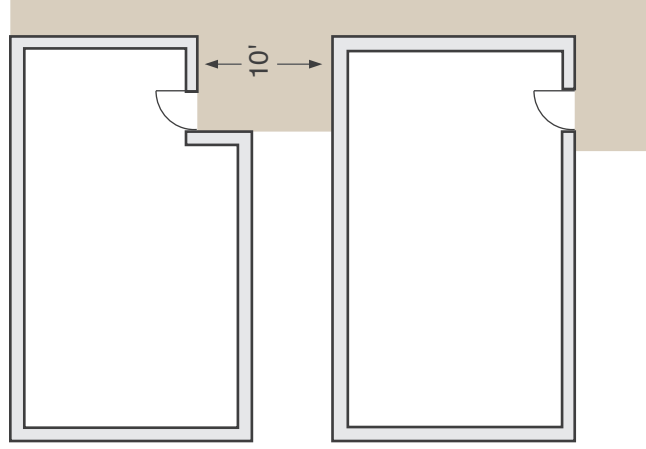

Draft Small Lot Design Standards Illustrations

2.Primary Entryways, All Small Lot Homes shall have a primary entryway. All primary entryways shall provide the address or unit identification, ornamental low-level lighting for illuminating the entry area, a landing area with enhanced paving material, different texture, or color.



Lighting, Identification, Pavement



Draft Small Lot Design Standards Illustrations

5. Varied Roofline, For any Small Lot Home façade fronting a public or private street exceeding two stories in height, the roofline shall be articulated by incorporating one of the following:

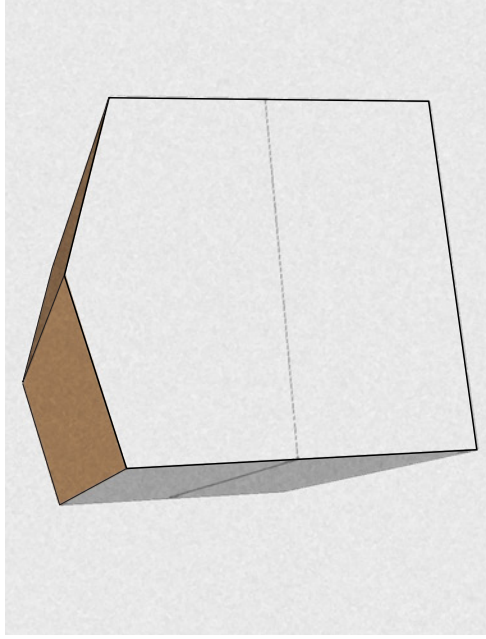

a. A roof with a slope equal or greater to 2" to 12", including but not limited to a sloped or curved roofline at the top of the dwelling.

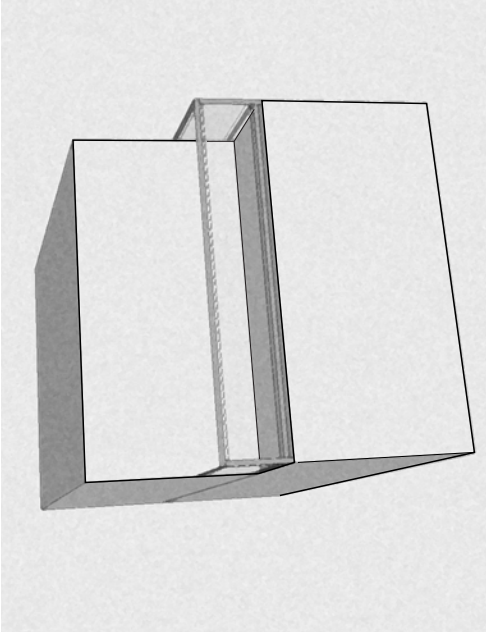

b. An open deck, with a minimum of 6 feet in depth.

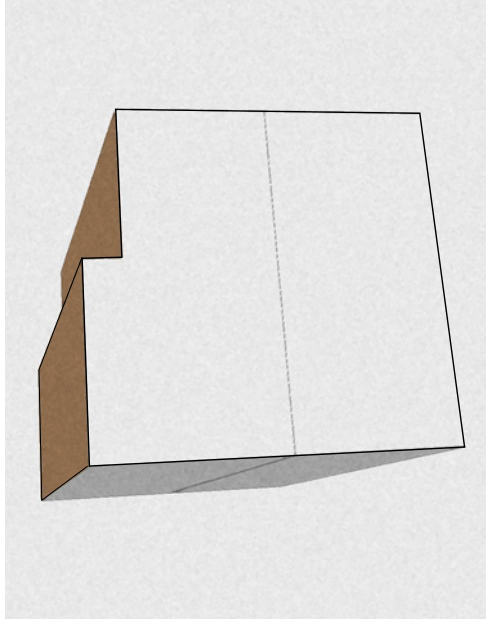

c. A flat roof with a minimum of 2' vertical height difference for a minimum of 10' horizontal along the roofline of each building facade.

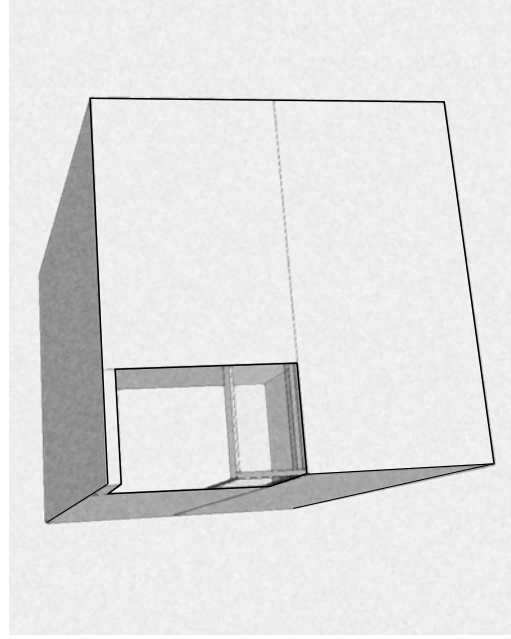

d. Any form of roofline modulation such as a corner balcony.

Draft Small Lot Design Standards Illustrations



6. Roof Decks, All roof decks not facing a public right-of-way or private street shall be oriented internally to the Subdivision, and be stepped back and screened from abutting neighbors.

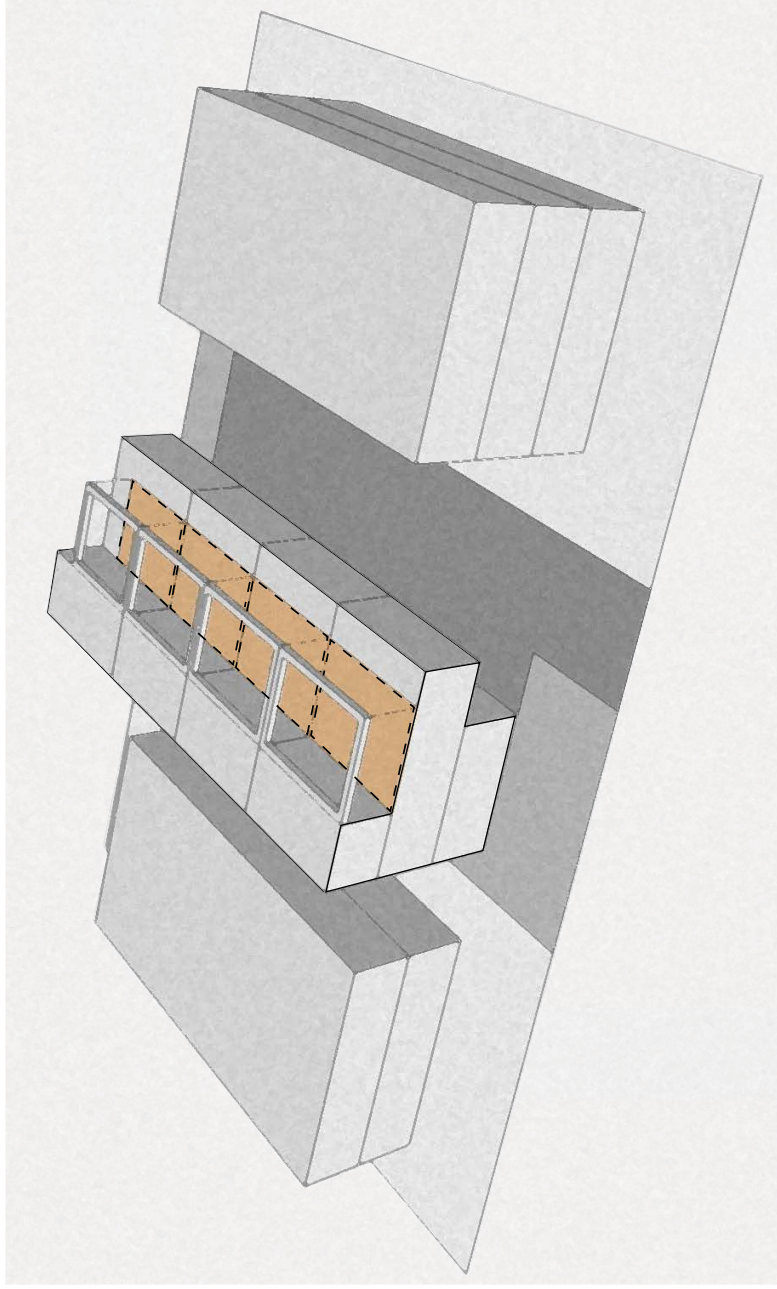

EXHIBIT C

DRAFT OVERVIEW

ADVISORY AGENCY MAP STANDARDS

SMALL LOT SUBDIVISION

CODE AMENDMENT AND POLICY UPDATE

MAP STANDARDS OVERVIEW – August 11, 2016



The Advisory Agency Map Standards are in addition to the provisions of the Small Lot Ordinance (LAMC §12.22 C.27) and will be required for a small lot subdivision map. They include the following:

1. A **Common Access Driveway** (easement) shall be provided for all small lot subdivisions with a minimum width of 10' that is clear to sky. The Common Access Driveway shall also provide a minimum ground floor width as follows:
 - 10' minimum for driveways serving up to 4 small lot homes.
 - 16' minimum for driveways serving 5 or more small lot homes.
2. A **Common Access Walkway** (easement) shall provide pedestrian access from a public street to the subdivision. The Common Access Walkway must be a minimum of 3' in width and remain unobstructed and open to sky.
3. A **Utility Easement** shall be provided per Department of Water and Power or similar agency requirements.
4. A **Maintenance Agreement** shall be created, composed of all property owners, to maintain all common areas and shared facilities such as trees, landscaping, trash, parking, community driveways, walkways, etc.
5. **Vehicular Guest Parking** shall be provided for all small lot subdivisions containing 8 or more newly constructed dwelling units at a ratio of 0.25 space per newly constructed dwelling unit. Guest parking shall be readily available to all guests and abut a Common Access Driveway or Common Access Walkway. Existing bungalow courts that are preserved per the Small Lot Ordinance Amendment are exempt from this requirement.
6. **Short-Term Bicycle Parking** shall be provided for all small lot subdivisions of 20 or more units at a ratio of 1 bicycle parking space per 10 dwelling units. Short-term bicycle parking shall be located within the subdivision in accordance with the Small Lot Design Standards.
7. All **Trash Pick-Up** shall be conducted on-site.
8. A Common **Open Space Easement** shall be created for all small lot subdivisions of 20 or more units at a ratio of 30 square feet of open space per unit. The Common Open Space Easement shall be designed in accordance with "common open space" provisions per the Small Lot Design Standards.

EXHIBIT D
SAMPLE ILLUSTRATIONS
FOR SMALL LOT GUIDE

Small Lot Ordinance + Map Standards

Perimeter Yards and Setbacks



Existing I Plan View

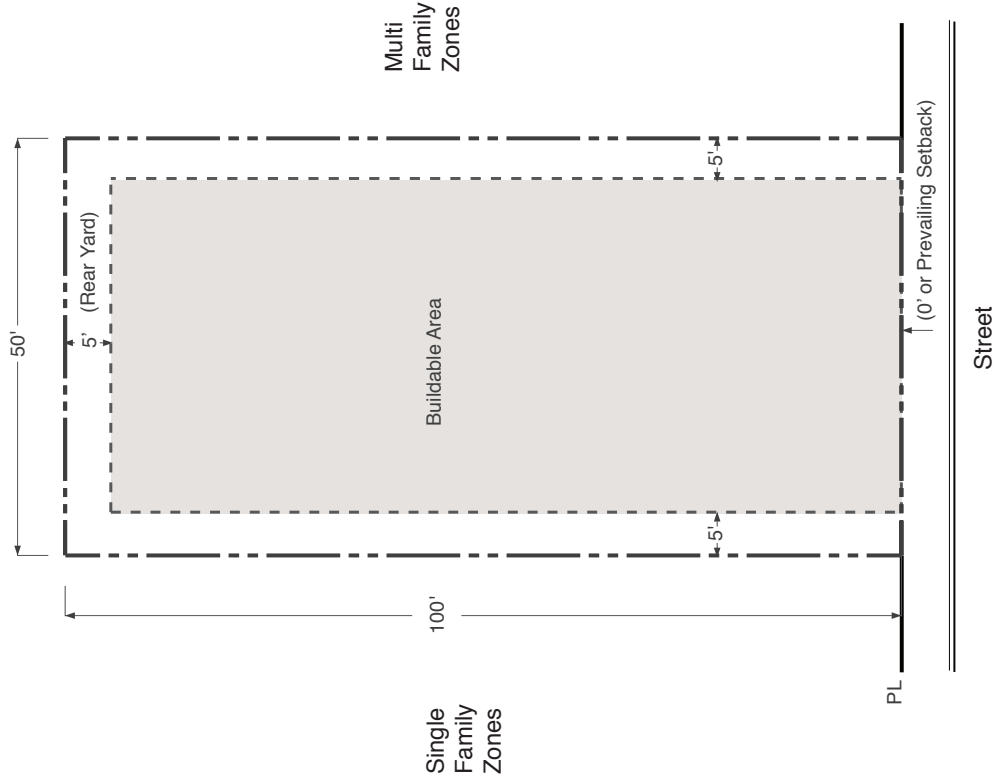

Proposed I Plan View

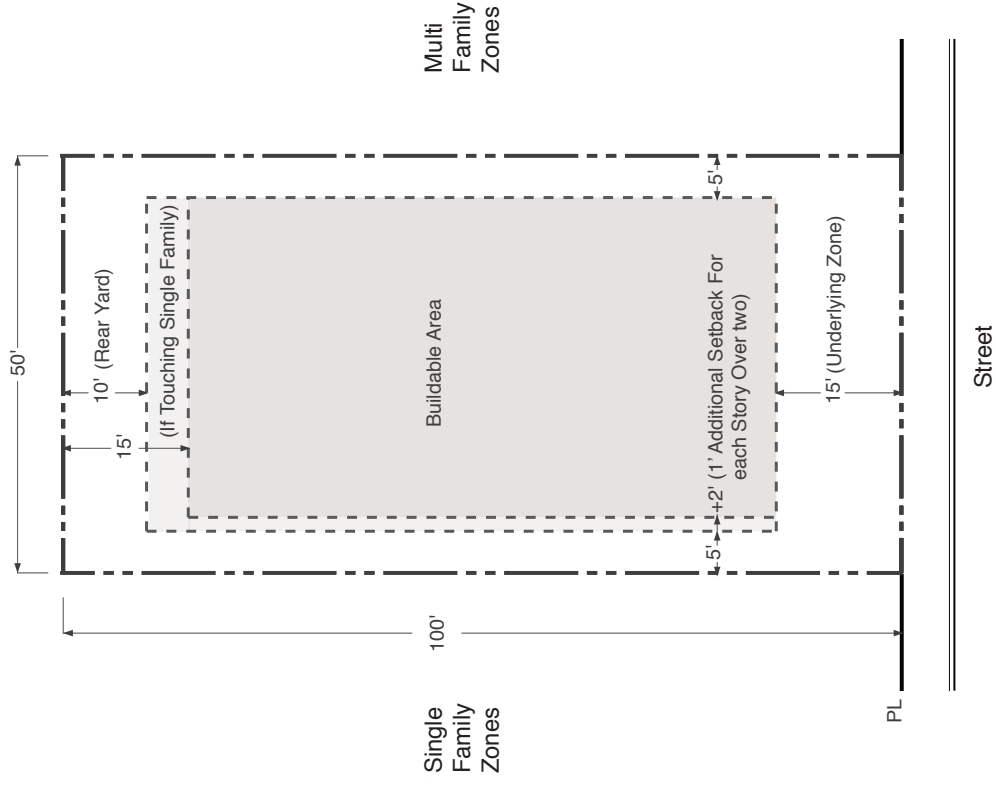

Small Lot Ordinance + Map Standards

Common Access Driveway



Existing I Plan View

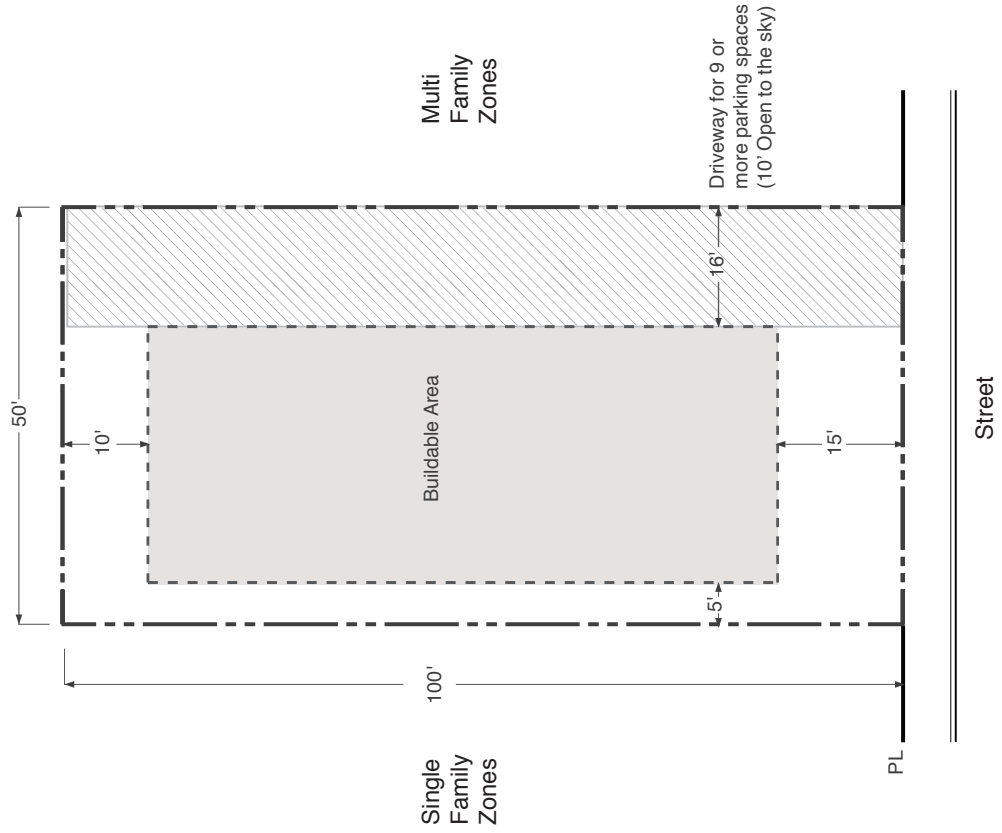

Proposed I Plan View

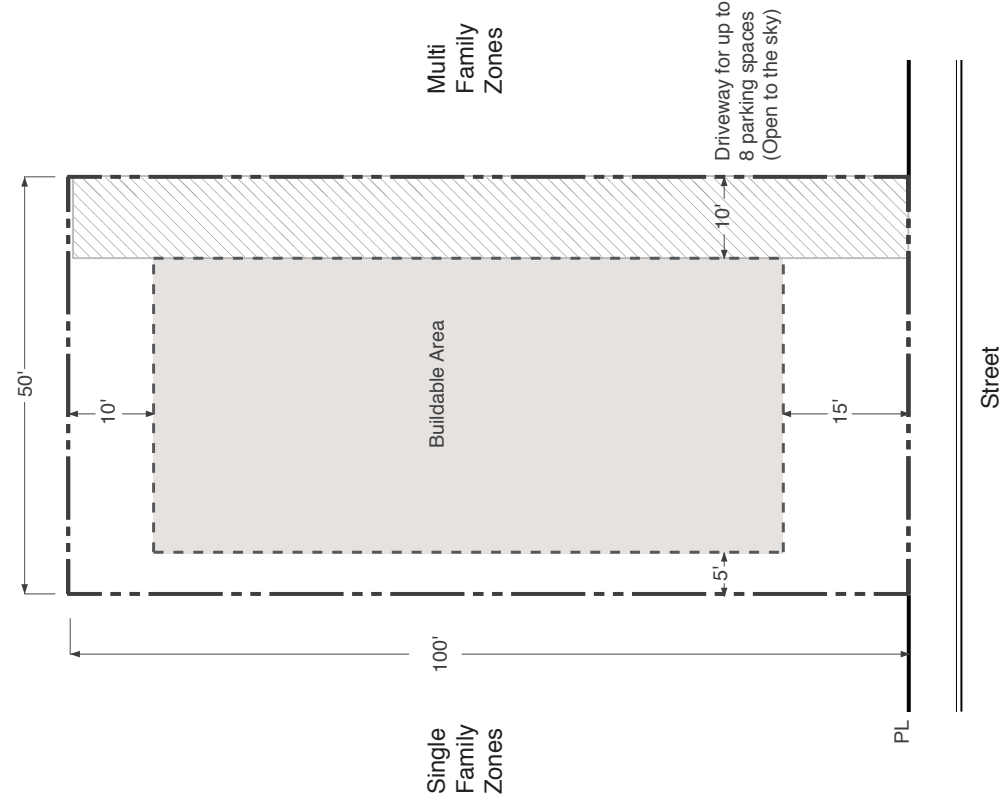

Small Lot Ordinance + Map Standards

Side Yards and Setbacks



Existing | Elevation

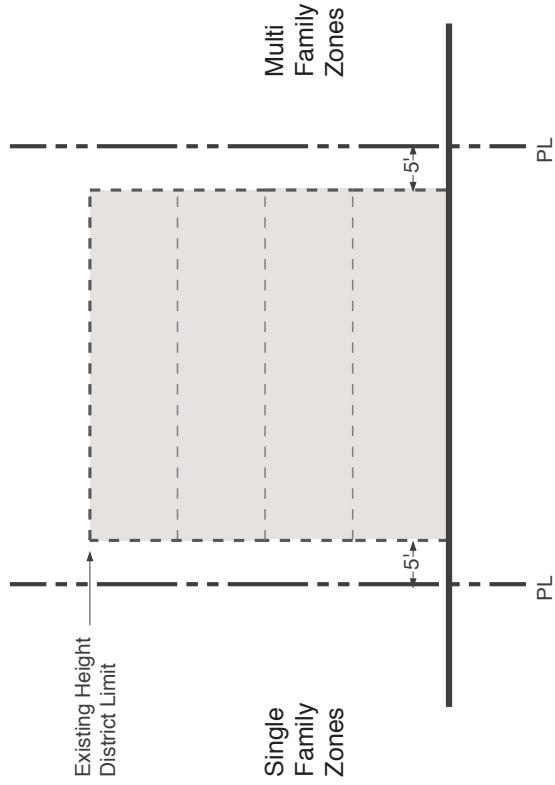

Proposed | Elevation

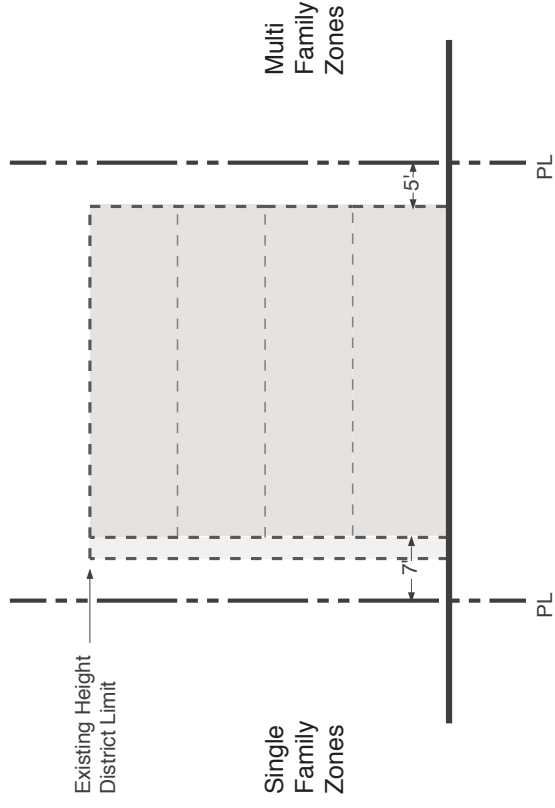

Small Lot Ordinance + Map Standards

Perimeter Yards and Setbacks



Existing Buildable Area

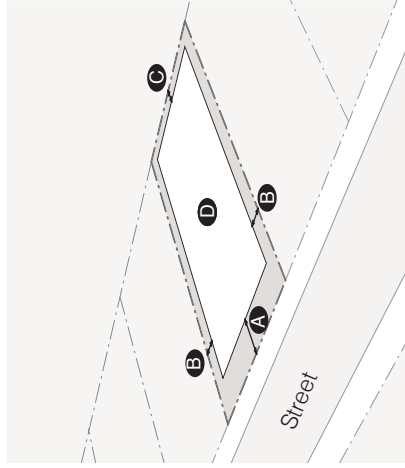

Setbacks

- A** Front Yard: 0' or Prevailing Setback
- B** Side Yard: 5'
- C** Rear Yard: 0' up to 5'
- D** Buildable Area

Proposed Buildable Area

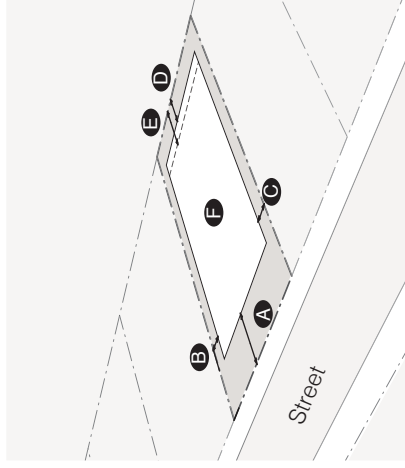

Setbacks

- A** Front Yard: Underlying Zone
- B** Side Yard: 5'
- C** Side Yard Abutting R1: Underlying Zone
- D** Rear Yard: 10'
- E** Rear Yard Abutting R1: Underlying Zone (15' or greater)
- F** Buildable Area

Existing Buildable Envelope

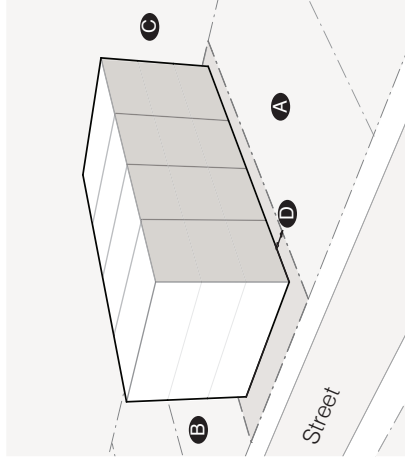

Setbacks

- A** Single Family Zones
- B** Multi Family Zones
- C** Existing Height District Limit
- D** Side Yard: 5'

Proposed Buildable Envelope

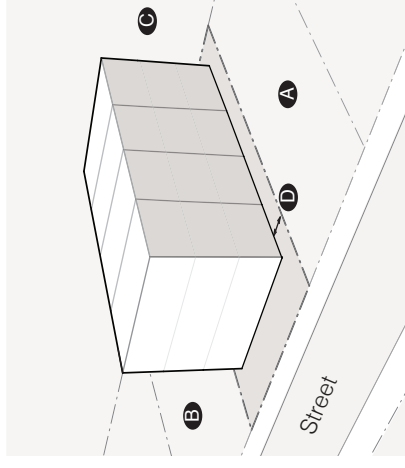



Setbacks

- A** Single Family Zones
- B** Multi Family Zones
- C** Existing Height District Limit
- D** Side Yard Abutting R1: Underlying Zone (Greater setback)

Small Lot Ordinance + Map Standards

Access and Driveway

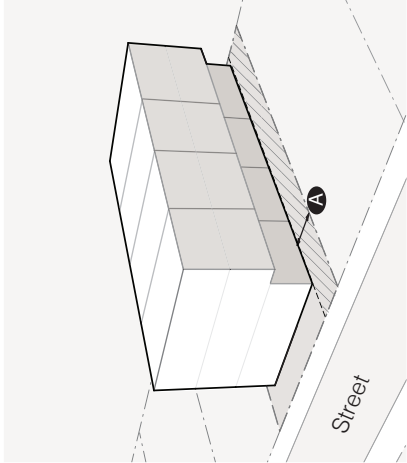
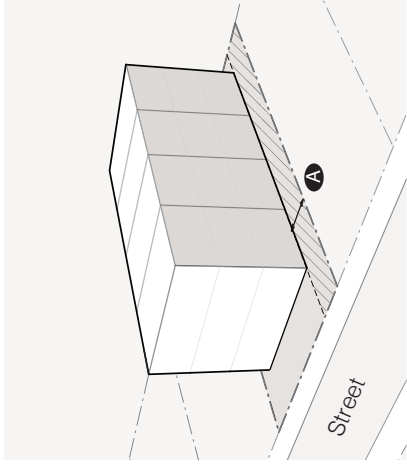

Existing	Proposed	Existing Envelope	Proposed Envelope
 <p>Diagram showing an existing lot with a driveway (A) and a buildable area (B) adjacent to a street.</p>	 <p>Diagram showing a proposed lot with a driveway (A) and a buildable area (B) adjacent to a street.</p>	 <p>Diagram showing an existing building envelope with a driveway (A) adjacent to a street.</p>	 <p>Diagram showing a proposed building envelope with a driveway (A) adjacent to a street.</p>
<p>Driveway</p> <ul style="list-style-type: none"> A Driveway Width: Code Requirement (Min) B Buildable Area 	<p>Driveway</p> <ul style="list-style-type: none"> A Driveway Width: 10' (Min) B Buildable Area 	<p>Driveway</p> <ul style="list-style-type: none"> A Open to the Sky Width: Code Requirement (Min) 	<p>Driveway</p> <ul style="list-style-type: none"> A Open to the Sky Width: 10' (Min)

Small Lot Ordinance + Map Standards

Double Lot Access and Driveway



Existing	Proposed	Existing Envelope	Proposed Envelope
 <p>A Driveway Width: Code Requirement (Min)</p> <p>B Buildable Area</p>	 <p>A Driveway Width: 16' (Min)</p> <p>B Buildable Area</p>	 <p>A Driveway Width: Code Requirement</p> <p>B Open to the Sky Width: Code Requirement (Min)</p>	 <p>A Driveway Width: 16' (Min)</p> <p>B Open to the Sky Width: 10' (Min)</p>

EXHIBIT E
SMALL LOT STATISTICS
2005 - 2016

Small Lot Statistics (2005-2016)

- Approximately 34% (114) of subdivisions recorded, creating 1,277 newly recorded lots

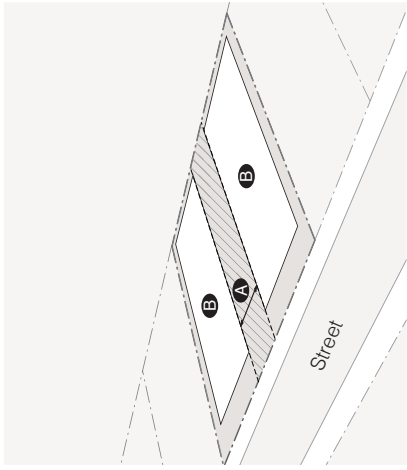
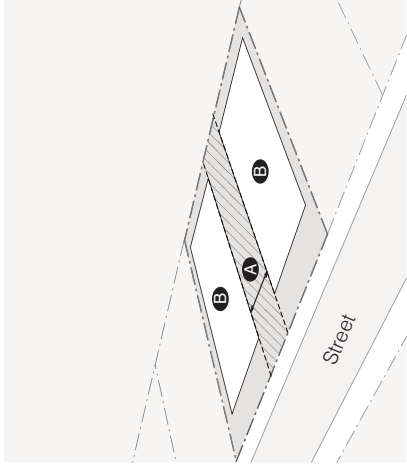
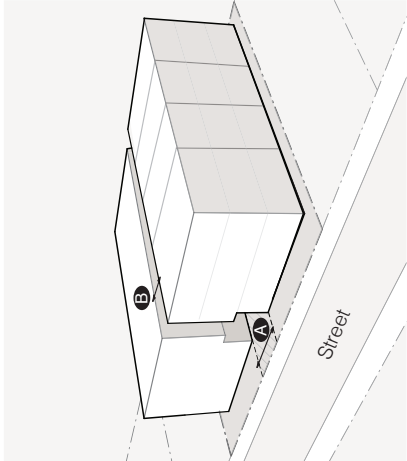
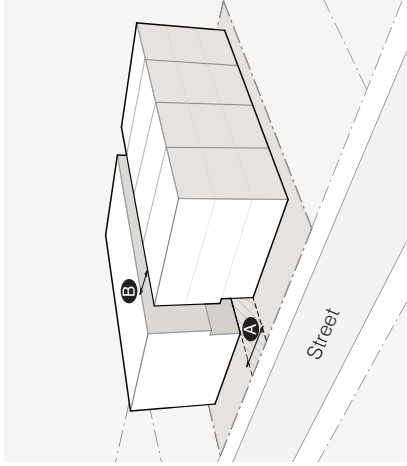
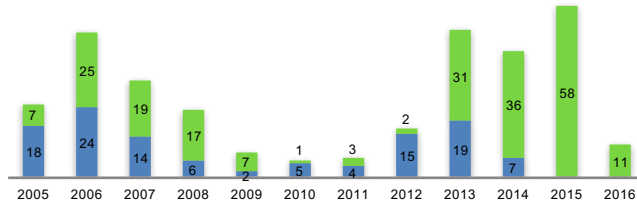

Not Recorded	217 cases	66%
Recorded	114 cases	34%

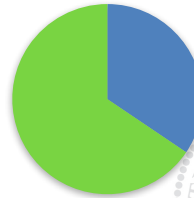

Los Angeles Department of City Planning

Small Lot Statistics (2005-2016)

- Approximately 90% of subdivisions have 19 or fewer units

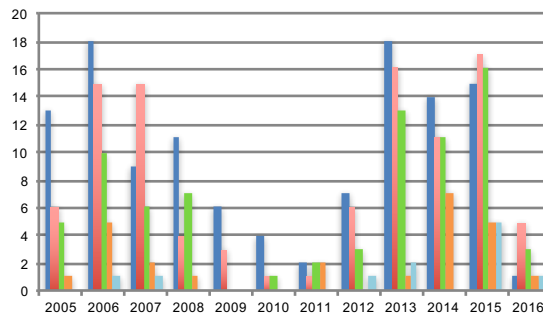
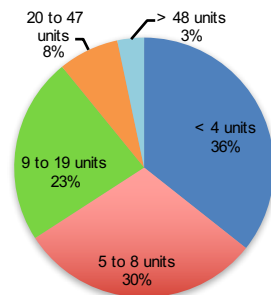

4 or fewer units	118 cases	36%
5 to 8 units	100 cases	30%
9 to 19 units	77 cases	23%
20 to 47 units	25 cases	8%
48 or more units	11 cases	3%
Total	331 cases	100%

Los Angeles Department of City Planning

Small Lot Statistics (2005-2016)

- Most common on RD1.5 or R3 zoned lots

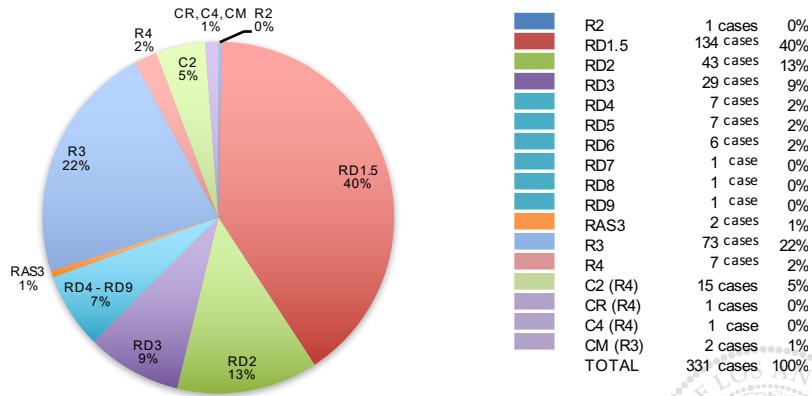

Los Angeles Department of City Planning

Small Lot Statistics (2005-2016)

- Generally spread evenly across APC areas in the City

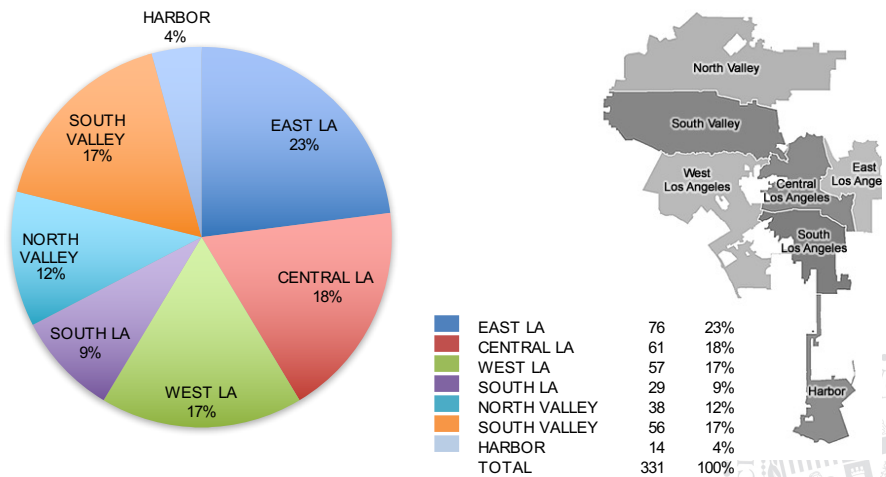

Los Angeles Department of City Planning

Small Lot Statistics (2005-2016)

- Accounts for approximately 9% of all map applications

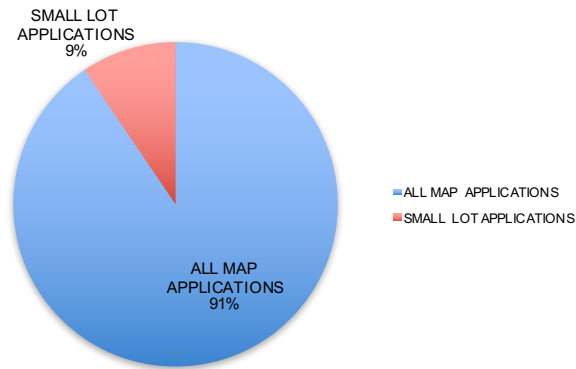

Los Angeles Department of City Planning

Small Lot Statistics (2005-2016)

- Approximately 16% of small lot subdivision cases have been appealed

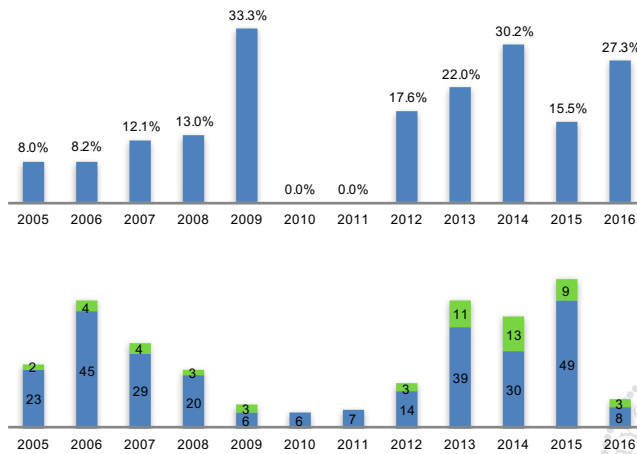

Los Angeles Department of City Planning

Small Lot Statistics (2006-2012)

- Small Lot Homes account for 1% of all dwelling units created

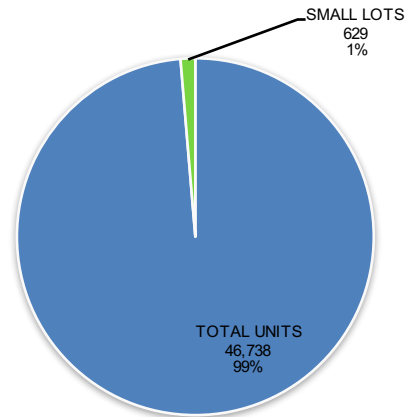

EXHIBIT F

CEQA Narrative for Categorical Exemption

ENV-2015-4500-CE

CALIFORNIA ENVIRONMENTAL QUALITY ACT (CEQA) NARRATIVE:**ENV-2015-4500-CE****I. PROJECT DESCRIPTION**

An amendment to Section 12.22-C,27 of the Los Angeles Municipal Code (**Small Lot Ordinance**), the “project,” will revise existing regulations regarding the requirements for a small lot subdivision discretionary application. It will create greater front and rear setback requirements; establish an incidental administrative process to allow for the review of plot plans; and create a new subdivision process for the reuse of existing dwellings of a typology typically called “Bungalow Courts”. They are existing dwellings built with multiple individual structures on one large lot as rental homes. It will also clarify the intent and procedural information as it relates to the Small Lot Ordinance. The proposed ordinance amends provisions of the existing Small Lot Ordinance only and is not considered a project under the CEQA Guidelines because there is no development, change in land use, intensity or density proposed as part of this project. Future requests for the approval of small lot subdivisions and the construction of Small Lot Homes require the review and action on a subdivision entitlement application and each application will be subject to environmental review on a site specific basis.

II. HISTORY OF THE SMALL LOT SUBDIVISION ORDINANCE AND EXISTING PROVISIONS

The Small Lot Ordinance was adopted in 2005 by the Los Angeles City Council as a new housing tool to encourage the development of alternative fee-simple homeownership in areas of zoned for multi-family and commercial uses. The Ordinance incentivized infill residential development in an effort to facilitate the development of more housing that resulted in new opportunities for property ownership. Through the division of land process, the Ordinance created an alternative housing form known as the Small Lot Home that is reflective of a hybrid of single- and multi-family housing. Small Lot Homes are able to combine fee simple (traditionally single-family) home ownership and condo living where there are minimal yards to maintain and shared amenities.

The Small Lot Ordinance was adopted under the *Definitions* (LAMC Section 12.03 – Lot) and *Exceptions* (LAMC Section 12.22-C) Sections of the Municipal Code to permit the subdivision of small lots in the multi-family, commercial, and parking zones. The provisions of the Ordinance exempted the minimum lot area and yard requirements of a property’s underlying zone, yet still relied on the zone to determine the permitted use, height, and density. As a result, Small Lot developments were permitted in zones that would otherwise only allow apartments and condominium units as a matter of right.

Whereas traditional tract or parcel map approvals in multi-family zones involve a subdivision of airspace rights for condominium units, small lot subdivisions involve a division of land into “small lots” that allow for fee simple ownership. In order to permit these subdivisions, the Ordinance established enabling provisions to allow legal access and frontage to a public or private street to be provided via an access easement. In addition, it permitted deviations from traditional lot and yard requirements that resulted in the ability of Small Lot Homes to look and function as row townhomes but be constructed so each unit is built to be detached and independently on its own individual “small lot.”

III. AMENDMENT TO THE SMALL LOT ORDINANCE

A Comprehensive Update to the Small Lot Subdivision Process

The City's proposed amendment to the Small Lot Ordinance is part of a comprehensive update to the Small Lot Subdivision process. The update involves an Advisory Agency Policy Update for small lots, which establishes enforceable development standards under the authority of the Advisory Agency¹, and the amendment to the Small Lot Ordinance. All proposed changes are intended to enhance the form, function, and livability of small lot maps projects, as well as provide clarity and consistency in the processing of Small Lot Subdivisions cases.

The amendment will not further make existing provisions of the Small Lot Ordinance any less restrictive. As described in the project description, the proposed changes to the existing Small Lot Ordinance will create *greater* front and rear setback requirements; establish an incidental administrative process that will allow for the review of proposed plot plans; and create a new subdivision process for the reuse of existing Bungalow Courts. Bungalow Courts were typically built with multiple individual units on one large lot as rental homes. However, many are deteriorating and currently require multiple variances or exceptions to enable their preservation and rehabilitation. The Code Amendment will enable the reuse of L.A.'s original small lots to become a reality through the Small Lot Ordinance. With the proposed Code Amendment, existing bungalow courts with four or more, older detached dwelling units on a single lot with a Certificate of Occupancy issued prior to 1950 may qualify to be subdivided into Small Lot Homes. In addition, the Ordinance language will be amended to clarify the procedures and intent of the small lot subdivision process, which is *to create alternative fee-simple home ownership within the multi-family and commercial zones, enable the construction of new small lot homes and provide opportunities for the preservation and rehabilitation of multiple older detached apartment homes located on a single lot to be reused as for-sale housing on individual small lots*. As a result of the comprehensive update to the Ordinance, the general massing of small lot subdivisions will be reduced and better integrated into existing Los Angeles neighborhoods.

The following identifies the proposed amendments to the existing provisions:

- Whereas the Code allows a 5-foot setback where the property line of the subdivision abuts a lot that is not created pursuant to the subdivision, *the amendment will require the map's front yard setback requirement to coincide with the property's underlying zone requirement. The*

¹ Granted under the authority of the California Subdivision Map Act, the Advisory Agency will issue a comprehensive policy update establishing Small Lot "Map Standards" related to access easements, utility easements, maintenance agreements, guest parking, trash enclosures, and open space easements. The most noticeable change established by the policy update will be the requirement that approved common access easements remain open to the sky at all times and increase the thresholds to be applicable to more projects to require guest parking and open space easements. This will reduce the presence of buildings which cantilever over driveways, resulting in the reduction of the top-heavy look of some small lot designs. The comprehensive set of Small Lot Map Standards will provide consistency and set clear expectations for a more streamlined process and will enhance the overall form and function of Small Lot developments. Details of the Policy Update will not be analyzed herein, an entitlement action is not required in order to be effectuated. All information regarding small lot subdivisions within the City of Los Angeles will be included within a comprehensive *Small Lot Guide* that will contain Small Lot background and preamble language, newly established Map and Design Standards, instructions for filing, and examples of best practices.

rear yard will be increased to 15 feet when the rear property line abuts a single-family zone and will be set at 10 feet when abutting all other zones. The side yard requirements for the map will remain at 5 feet.

- *Whereas the Code allows a minimum lot width of 16 feet for each new small lot, the amendment will increase the requirement to an 18-foot minimum.*
- *Whereas the Code prohibits proposed structures from occupying more than 80% of an individual lot, unless project is providing common open space, the amendment will further restrict lot coverage and prohibit structures from occupying no more than 75% of an individual lot area, unless providing common open space.*
- *Whereas the Code states that vehicular access may be provided to either a lot containing a dwelling unit or to its required parking spaces by way of a street or alley frontage, driveway access or similar access to a street, the amendment clarifies that access shall be provided to every Small Lot Home as well as its designated parking, by way of street or alley frontage, or common access easement.*
- *Whereas the Code prohibits fences and walls within 5 feet of the front lot line from being more than 3 ½ feet in height and fences and walls within 5 feet of the side and rear lot lines from being more than 6 feet in height, the amendment prohibits fences and walls from exceeding the allowed height in the exterior setback areas based on the boundary of the proposed lot for subdivision.*

These proposed changes will result in overall modifications to the general design of small lot subdivision maps. The changes will result in an overall reduction to the massing of Small Lot Homes that will typically range between 10% and 20%. Increasing the required minimum lot width and reducing the permitted lot coverage of each resulting subdivided lot will equate to reduced building footprints with slightly larger minimum lot sizes. Incidentally, as part of the Small Lot “Map Standards,” modified requirements for easements, when provided, will ensure that each proposed new Small Lot Home will have ease of access from a street or alley to its individual unit and required parking. Increased yard setbacks to the front and rear lot lines of the perimeter of the subdivision will result in new construction that is akin to other multi-family structures. Finally, changes to language related to new fences clarify the original intent of such language to ensure that 6-foot tall fences are not proposed in the front yard of the lot to be subdivided.

As described, the result of these increased requirements will result in reduced massing of newly constructed Small Lot Homes and will additionally result in the provision of more open spaces throughout new projects. The increased front and rear yard setbacks, increased minimum lot width, along with established design standards will facilitate a better integration of small lot subdivisions into existing established neighborhoods zoned for multi-family uses.

New Administrative Clearance:

The Subdivision Map Act Section 66415 defines the “Advisory Agency” as a designated official or an official body charged with the duty of making investigations and reports on the design and improvement of proposed divisions of real property, the imposing of requirements or conditions thereon, or the kinds, nature and extent of the design and improvements, or both, recommended or decided by the advisory agency to be required. The Advisory Agency is granted the authority to regulate the form and function of a tract or parcel map and further condition the map as necessary;

however, it is limited from regulating the design of buildings when considering a proposed map. The Map Act, however, does extend the regulating powers of building design if and when a local jurisdiction (i.e. the City of Los Angeles) creates a new review process for building design. As outlined in the Map Act (Section 66473), a local agency shall disapprove a map for failure to meet or perform any of the requirements of conditions imposed by local ordinance.

As such, the Code Amendment would establish a separate Administrative Clearance process to require that Small Lot plot plans be reviewed for compliance with Design Standards that will be established through the ordinance adoption process. This clearance will be required of every new small lot subdivision request, including modifications, and shall be filed simultaneously with the subdivision request. New project requests for small lot subdivisions will be required to meet design standards which relate to “Building Design,” “Pedestrian Connectivity and Access,” and “Landscaping and Front Yard Uses.” In addition, projects with proposed mixed use small lot homes will have additional required design standards and proposed “Bungalow Court projects” will be subject to a separate set of standards due to the unique approach to allow for the preservation of older existing typology .

“Bungalow Court” Small Lot Subdivisions:

The Small Lot Ordinance Amendment will create a mechanism to allow for the conversion of “Bungalow Courts” detached apartment dwellings located on one lot into individual fee-simple small lot homes. The amendment would allow this to be done without, for the most part, requiring various zone variances, adjustments, or zoning administrator determinations that would otherwise be required to legalize an existing structure that may be out of compliance with zoning regulations that were established after its original construction.

IV. FORESEEABLE ACTIVITIES FROM THE PROJECT (AMENDMENT)

The amendment (“project”) to the existing Small Lot Ordinance would establish enforceable development and design standards and provide the public and development community with more consistency, a consistent procedures, and clearer expectations. The amended language will better guide the future planning and development of small lot subdivisions; however, it will not directly increase the production of new Small Lot Homes. It will not further incentivize nor make the Small Lot Ordinance any less restrictive.

V. ENVIRONMENTAL REVIEW UNDER CEQA

In accordance with California Environmental Quality Act (CEQA) Guidelines, this Ordinance Amendment is exempt under the State CEQA Guidelines Section 15061(b)(3) as well as the City of Los Angeles CEQA Guidelines, Article II, Section 2, class (m). Section 15061(b)(3) establishes the general rule that CEQA applies only to projects that have the potential to cause a significant effect on the environment, and where it can be seen with certainty that there is no possibility that the activity may have a significant effect on the environment, the activity is not subject to CEQA. In addition, the City’s CEQA Guidelines, Article II, Section 2, Class (m) exempt the adoption of ordinances that do not result in an impact on the physical environment. The proposed ordinance amends provisions of the

existing Small Lot Ordinance only and is not considered a project under the CEQA Guidelines because there is no development, change in land use, intensity or density proposed as part of this project. Future requests for the approval of small lot subdivisions and the construction of Small Lot Homes require the review and action on a subdivision entitlement application and each will be subject to environmental review on a site specific basis.

- A. *State CEQA Guidelines Section 15061(b)(3) states that a project is exempt from CEQA if it is covered by “the general rule that CEQA applies only to projects, which have the potential for causing a significant effect on the environment. Where it can be seen with certainty that there is no possibility that the activity in questions may have a significant effect on the environment, the activity is not subject to CEQA.”*

The proposed code amendment would modify the regulations applied to future applications requesting the approval of a small lot subdivision map. The code amendment project itself does not include any specific physical development. The proposed code amendment would not change any existing City regulations governing building heights, nor would it change allowed land uses or development projects to which the proposed code amendment would apply. No increases in land use, density, intensity, or distribution are proposed, and no individual development would be approved by the adoption of the code amendment. No changes in land use designations are proposed nor would result from the approval of the proposed changes to the Small Lot Ordinance. Implementation of the proposed changes to existing small lot subdivision regulations through any future requested project within the City of Los Angeles would be required to be consistent with the General Plan, applicable Community Plans, and Zoning Ordinance as amended by this code amendment project.

- B. *City of Los Angeles Environmental Quality Act Guidelines, Article II, Class 2(m), consists of the adoption of ordinances that do not result in impacts on the physical environment.*

The proposed code amendment (“project”) would result in changes to existing regulations applied to future discretionary applications requesting the approval of a small lot subdivision map. The amendment will require greater front and rear setbacks of small lot projects; create a new subdivision process for the division of existing apartment homes into fee simple homes; establish an administrative process that will allow for the review development plans; will clarify the intent and procedural information as it relates to the Ordinance. The project itself does not include any specific physical development. Any future small lot subdivision development project within the City of Los Angeles would be required to be consistent with the General Plan, applicable Community Plans, and Zoning Ordinance as amended by this project and would be subject to CEQA review.

VI. EXCEPTIONS TO THE USE OF CATEGORICAL EXEMPTIONS

Given that the proposed project is a code amendment that involves regulatory changes and does not include any specific physical development, Planning staff evaluated the exceptions to the use of Categorical Exemptions for the proposed ordinance listed in “CEQA Guidelines” Section 15300.2 and determined that none of the exceptions apply to the proposed ordinance as described below:

- A. Location. *Classes 3, 4, 5, 6, and 11 are qualified by consideration of where the project is to be located -- a project that is ordinarily insignificant in its impact on the environment may in a particularly sensitive environment be significant. Therefore, these classes are considered to apply all instances, except where the project may impact on an environmental resource of hazardous or critical concern where designated, precisely mapped, and officially adopted pursuant to law by federal, state, or local agencies.*

Categorical Exemptions, Classes 3, 4, 5, 6, and 11 have not been considered for the proposed ordinance amendment. Therefore, the exception is not applicable.

- B. Cumulative Impact. *All exemptions for these classes are inapplicable when the cumulative impact of successive projects of the same type in the same place, over time is significant.*

The proposed amendment to the Small Lot Subdivision Ordinance (the “project”) will not result in any cumulative impacts. A successive project of the same type would be equivalent to a subsequent amendment to the Ordinance. Any such amendment; however, would not result in cumulative impacts because they would not result in the immediate approval of a physical development at a specific location.

- C. Significant Effect Due to Unusual Circumstances. *A categorical exemption shall not be used for an activity where there is a reasonable possibility that the activity will have a significant effect on the environment due to unusual circumstances.*

There is no reasonable possibility that the proposed amended ordinance will have a significant effect due to unusual circumstances. The existing Small Lot Ordinance permits small lot subdivisions to occur, on a discretionary land use entitlement basis, in zones that allow for multi-family housing where the allowable density is calculated as it would be for the development of apartments or condominiums. The potential tentative and final approval of a subdivision map is not unusual in that this procedure is a standardized process. The construction of one or more Small Lot homes is not unusual in that this process is required to adhere to regulated building codes and construction methods. While unusual circumstances may occur during the entitlement and construction of individual Small Lot developments, the proposed amendment to the Ordinance will not result in the immediate development of a Small Lot Home. The amendment will not make any such development a by-right or ministerial project/process, that could occur without appropriate CEQA review.

- D. Scenic Highway. *A categorical exemption shall not be used for a project which may result in damage to scenic resources, including but not limited to, trees, historic buildings, rock outcroppings, or similar resources, within a highway officially designated as a state scenic highway. This does not apply to improvements which are required as mitigation by an adopted negative declaration or certified EIR.*

The proposed amended ordinance will not damage scenic resources within a designated scenic highway. The proposed code amendment to the Small Lot Ordinance would alter the regulations applied to future applications requesting the approval of a small lot subdivision map. The code amendment project itself does not include any specific physical development.

- E. Hazardous Waste Site. *A categorical exemption shall not be used for a project located on a site which is included on any list compiled pursuant to Section 65962.5 of the Government Code.*

Individual future development projects that may apply for the discretionary subdivision approval outlined in LAMC 12.22-C,27 may be located on or near sites that contain hazardous materials, contamination, or other hazards. However, no increases in land use density, intensity or distribution, are proposed as part of the proposed code amendment. No specific development is proposed, and no individual development would be approved by adoption of the code amendment. The amendment will not make Small Lot subdivisions a by-right or ministerial project/process that could occur without appropriate CEQA review. In addition, a number of existing state and federal laws and programs apply to hazards and hazardous materials and would apply to subsequent future individual development projects. These include the Resource Conservation and Recovery Act, California Fire Codes, Senate Bill 1082 (Facilities Subject to Corrective Action), Department of Health Services regulations, and Department of Housing regulations. Finally, Municipal Code Section 54.05 requires that a hazardous substance clearance report, including provisions for site remediation if warranted, be approved by the County Health Department and recorded with the County for sale or transfer of any property, upon which there has been an unauthorized disposal or release of a hazardous substance.

- F. Historical Resources. *A categorical exemption shall not be used for a project which may cause a substantial adverse change in the significance of a historical resource.*

The proposed project involves regulatory changes and does not include any specific physical development. The proposed amendments would not facilitate nor further encourage new development projects, and would only affect discretionary, small lot subdivision requests. All future development projects to which the proposed code amendment would apply will require CEQA review, which would include an assessment of the project's potential impacts to historic and cultural resources, and would be subject to the City's existing policies and procedures designed to evaluate and protect such resources. No specific construction or physical changes to existing buildings are proposed as part of the project. In addition, because of existing regulations and protections in place, including required CEQA review for projects with potential impacts to historic resources, the adoption of the proposed code amendment is not anticipated to have any adverse impacts to historic resources.

VII. ADDITIONAL FACTUAL SUPPORT

Below is a consideration of all categories on the Initial Study Checklist to demonstrate further that the proposed amended ordinance qualifies for the listed categorical exemptions and that even if a threshold test is met for any exception, there is no substantial evidence supporting a fair argument that a significant impact would occur from the Project.

A. *Aesthetics*

The proposed code amendment (“project”) would alter the regulations applied to future discretionary applications requesting a small lot subdivision approval pursuant to Los Angeles Municipal Code (LAMC) Section 12.22-C,27. The project will require greater front and rear yard setbacks; increase minimum lot widths; reduce the amount of lot area an individual home can occupy; clarify existing access and fence requirements; establish a new subdivision process for the reuse of existing apartment homes into individual fee simple homes, establish an administrative process that will effectively establish Small Lot “Design Standards;” and will clarify the intent and procedural information as it relates to the Ordinance. The project itself does not include any specific physical development. The amendment would not change existing City regulations governing building heights, nor would it change allowed land uses or development intensity within the City of Los Angeles. All future discretionary development projects to which the proposed code amendment would apply will require CEQA review, and would include an assessment of the project’s visual impacts upon existing neighborhood character. In light of the above, the proposed amended ordinance would have no new impacts on aesthetics.

B. *Agricultural and Forest Resources*

The proposed code amendment would alter the regulations applied to future applications requesting a small lot subdivision approval within the City of Los Angeles, pursuant to LAMC 12.22-C,27. The project will require greater front and rear yard setbacks; increase minimum lot widths; reduce the amount of lot area an individual home can occupy; clarify existing access and fence requirements; establish a new subdivision process for the adaptive reuse of existing apartment homes into individual fee simple homeownership, establish an administrative process that will effectively establish Small Lot “Design Standards;” and will clarify the intent and procedural information as it relates to the Ordinance. A Small Lot subdivision is a discretionary action that is only permitted in zones that allow for multi-family housing where the allowable density is calculated as it would be for the development of apartments or condominiums. Further, the proposed regulations themselves do not include any specific development and do not encourage conversion of agricultural land to non-agricultural uses or impacts to land under Williamson Act contract. No impacts to agricultural resources would occur.

C. *Air Quality*

Implementation of the code amendment project would not increase population levels or the net density in the City of Los Angeles, as small lot subdivisions are only permitted in zones that already allow for multi-family housing where the allowable density is calculated as it would be for the development of apartments or condominiums. No increases in land use, density, intensity, or distribution are proposed, and no individual development would be approved by

the adoption of the code amendment. Furthermore, no changes in land use designations are proposed nor would result from the approval of the proposed changes to the Small Lot Ordinance. Implementation of the proposed changes through any future requested project within the City of Los Angeles would be required to be consistent with the General Plan, applicable Community Plans, and Zoning Ordinance as amended by this code amendment project. As the project would not contribute to unplanned population growth in excess of that forecasted by the South Coast Air Quality Management District (SCAQMD), no impact would occur. Thus, no impact is anticipated from new stationary sources of pollutants, such as generators or household uses (stoves, heaters, fireplaces etc). The code amendment does not include any specific physical development. Overall air quality would be unaffected by the adoption of the code amendment and no adverse impacts would occur.

D. *Biological Resources*

Biological resources may be found throughout the City of Los Angeles. However, the proposed code amendment project itself does not include any physical development that would affect these resources, and the proposed regulations would not encourage tree removal, damage to identified species, riparian communities, or sensitive natural habitats, or any increase in development intensity or distribution in the project area. All future development projects to which the proposed code amendment would apply will require CEQA review, which would include an assessment of the project's biological impacts. Implementation of the proposed code amendment through future development projects would not represent any change in how future development would affect biological resources. No adverse impacts to biological resources, including identified species, riparian communities or sensitive natural communities, wetlands, protected trees, and habitats, are anticipated from the proposed code amendment.

E. *Cultural Resources*

The proposed project involves regulatory changes and does not include any specific physical development. The proposed amendment would not facilitate nor further encourage new development projects, but would affect discretionary, small lot subdivision requests. All future development projects to which the proposed code amendment would apply will require CEQA review, which would include an assessment of the project's potential impacts to historic and cultural, archaeological, and paleontological resources and would be subject to the City's existing policies and procedures, designed to evaluate and protect such resources. No specific construction or physical changes to existing buildings are proposed as part of the project. In addition, because of existing regulations and protections in place, including required CEQA review for projects with potential impacts to any historic, archaeological, paleontological and human remains resources, the adoption of the proposed code amendment is not anticipated to have any adverse impacts to cultural resources.

F. *Geology and Soils*

Los Angeles County, like most of Southern California, is a region of high seismic activity and is therefore subject to risk and hazards associated with earthquakes. Several active faults within the region are considered capable of affecting property throughout the City of Los Angeles. Erosion potential from site preparation for larger projects would be largely addressed through standard erosion control BMPs that are required during project construction; for example,

projects with greater than one acre of ground disturbance require State Water Resources Control Board Storm Water Pollution Prevention Plans.

The proposed project involves a code amendment that does not include any specific physical development. No increases in land use density, intensity, or distribution are proposed. No specific development is proposed nor would be approved by adoption of the code amendment. Future development projects, to which the amended Small Lot Ordinance would be applicable, would be subject to the requirements of the International Building Code and the California Building Code, which would ensure that the design and construction of new structures are engineered to withstand the expected ground acceleration, liquefaction, or other hazards such as landslides, expansive soils, and soil erosion, that may occur on-site. With no specific development proposed as part of this code amendment project, no impacts to Geology and Soils are anticipated to result.

G. *Greenhouse Gas Emissions*

The project will require greater front and rear yard setbacks; increase minimum lot widths; reduce the amount of lot area an individual home can occupy; clarify existing access and fence requirements; establish a new subdivision process for the adaptive reuse of existing apartment homes into individual fee simple homeownership, establish an administrative process that will effectively establish Small Lot "Design Standards;" and will clarify the intent and procedural information as it relates to the Ordinance. No development is proposed as part of or would be facilitated by the code amendment project, and no increases in land use density, intensity, or distribution are proposed. Thus, no impacts to the generation of greenhouse gas emissions are anticipated occur, either directly or indirectly as a result of the adoption of the code amendment.

H. *Hazards and Hazardous Materials*

The proposed project involves a code amendment that does not include any specific physical development. No increases in land use density, intensity, or distribution are proposed and no specific development is proposed nor would be approved by adoption of the code amendment.

Individual future development projects that may apply for a discretionary small lot subdivision approval pursuant to LAMC Section 12.22-C,27 may be located on or near sites containing hazardous materials, contamination, or other hazards. In such cases, future projects would be subject to existing state and federal laws and programs apply to the handling of hazards and hazardous materials. These include the Resource Conservation and Recovery Act, California Fire Codes, Senate Bill 1082 (Facilities Subject to Corrective Action), Department of Health Services regulations, and Department of Housing regulations. Finally, Municipal Code Section 54.05 requires that a hazardous substance clearance report, including provisions for site remediation if warranted, be approved by the County Health Department and recorded with the County for sale or transfer of any property, upon which there has been an unauthorized disposal or release of a hazardous substance.

Additional safety hazards related to existing airport facilities would not occur because no new individual development or increases in land use density, intensity, or distribution are proposed as part of the proposed code amendment. The circulation network would remain unchanged

under the proposed regulations and existing requirements for fire and other emergency access would continue to be applied to new development as it is proposed and reviewed.

The City of Los Angeles does contain large areas of undeveloped lands adjacent to urban areas where the possibility of wildfires exists at the wildland-urban interface; however, no specific development project is being proposed by the code amendment. Future projects that apply for a small lot subdivision approval will be required to adhere to all existing regulatory measures that will ensure hazards and hazardous materials appropriately handled. As such, no adverse impacts would occur from the adoption of the code amendment.

I. *Hydrology and Water Quality*

The project will require greater front and rear yard setbacks; increase minimum lot widths; reduce the amount of lot area an individual home can occupy; clarify existing access and fence requirements; establish a new subdivision process for the adaptive reuse of existing apartment homes into individual fee simple homeownership, establish an administrative process that will effectively establish Small Lot “Design Standards;” and will clarify the intent and procedural information as it relates to the Ordinance. No specific development is proposed nor would be approved as part of the code amendment project and no increases in land use density, intensity, or distribution would be granted.

All future development projects to which the proposed code amendment would apply will require CEQA review, which would include an assessment of the project's' potential impacts to hydrology and water quality. Any new project that may have any potential to degrade water quality would be subject to the provisions of the Low Impact Development (LID) Ordinance (Ordinance No. 181,899) to ensure that projects mitigate runoff and stormwater pollution. Based upon this, the proposed amended ordinance is not expected to result in any hydrology or water quality impacts.

J. *Land Use and Planning*

The 2013-2021 Housing Element of the City’s General Plan identifies the City’s housing conditions and needs and establishes goals, objectives, and policies for a growth strategy with programs to achieve livable neighborhoods for all residents. Objective 1.1-3 of the Housing Element states that the City should facilitate the development of small lot subdivisions, which permit detached, fee-simple home ownership on lots as small as 600 square feet, thus providing more affordable alternative for-sale housing types within commercial and multi-family residential zones. The City should identify obstacles in the development standards, code requirements, and procedures to developing small lot subdivisions and propose revisions to the Small Lot Subdivision Guidelines, clarification [policy] memos, Code Amendments or other measures to eliminate impediments.

The project will require greater front and rear yard setbacks; increase minimum lot widths; reduce the amount of lot area an individual home can occupy; clarify existing access and fence requirements; establish a new subdivision process for the adaptive reuse of existing apartment homes into individual fee simple homeownership, establish an administrative process that will effectively establish Small Lot “Design Standards;” and will clarify the intent and procedural information as it relates to the Ordinance. The proposed amendment to the

Ordinance, alone, will not result in the immediate development of any small lot homes, nor will it result in any changes to land use designations, increases in density or permitted height.

The Small Lot Ordinance permits these subdivisions to occur, on a discretionary land use entitlement basis, in zones that allow for multi-family housing where the allowable density is calculated as it would be for the development of apartments or condominiums. The amendment will not make any such development project a by-right or ministerial project/process, that could occur without the appropriate level of CEQA review.

The proposed code amendment would modify the regulations applied to future applications requesting a discretionary approval for a small lot subdivision for properties permitting multi-family residential uses within City of Los Angeles, per LAMC 12.22-C,27. The proposed code amendment would not change any other existing City regulations, nor would it change allowed land uses or development projects to which the proposed code amendment would apply to and require CEQA review. As a result, no adverse impacts to land use and planning would occur.

K. *Mineral Resources*

The proposed code amendment would modify the regulations applied to future applications requesting the approval of a small lot subdivision map; however, it does not include any specific physical development. The proposed code amendment would not change any existing City regulations governing building heights nor would it change allowed land uses or development projects to which the proposed code amendment would apply. All future projects to which the proposed code amendment would apply will require CEQA review, which would include an assessment of the project's potential impacts to mineral resources. However, at this time no specific development is proposed, and no development would be specifically approved by adoption of the code amendment. Therefore, no impacts to mineral resources would occur.

L. *Noise*

The proposed code amendment would modify the regulations applied to future applications requesting the approval of a small lot subdivision map. The proposed code amendment, however, would not change any existing City regulations governing building heights, density, or land use designations. No specific development is proposed, and no development would be specifically approved by adoption of the proposed code amendment. All future small lot development projects will require CEQA review and would be subject to noise regulations developed and implemented by the City to mitigate construction and operational impacts. Due to the fact the project does not include any development proposals or entitlements, adoption of the proposed code amendment would not place sensitive receptors in areas, subject to noise that exceeds noise standards, nor will it impact any existing or planned airport plans. As a result, the project would not create any adverse noise impacts.

M. *Population and Housing*

The project will require greater front and rear yard setbacks; increase minimum lot widths; reduce the amount of lot area an individual home can occupy; clarify existing access and fence requirements; establish a new subdivision process for the adaptive reuse of existing apartment homes into individual fee simple homeownership, establish an administrative process that will effectively establish Small Lot “Design Standards;” and will clarify the intent and procedural information as it relates to the Ordinance. The amendment does not propose any increases in land use density, intensity, or distribution.

No specific development is proposed nor would any individual development be approved as part of the proposed code amendment. No housing is proposed for construction or removal, and no population inducing development or regulations are proposed. The proposed amendment would modify the regulations applied to future small lot subdivision applications. The amendment would not change any existing City regulations governing building heights, nor would it change permitted land uses to which the proposed code amendment would apply. All future development projects will require CEQA review, which would include an assessment of an individual project's' potential impacts to population and housing. Therefore, no new population and housing impacts would occur.

N. *Public Services*

The project will require greater front and rear yard setbacks; increase minimum lot widths; reduce the amount of lot area an individual home can occupy; clarify existing access and fence requirements; establish a new subdivision process for the adaptive reuse of existing apartment homes into individual fee simple homeownership, establish an administrative process that will effectively establish Small Lot “Design Standards;” and will clarify the intent and procedural information as it relates to the Ordinance.

Due to the fact that no development is proposed as part of the code amendment to the Small Lot Ordinance, and no increases in land use density, intensity, or distribution are proposed, the amendment alone would not increase the demand for fire or police protection services, schools, parks, or other public services. No new facilities would be required, and no alterations to existing facilities would result from adoption of the proposed code amendment. As a result, no adverse impacts related to public services or public services facilities would occur.

O. *Recreation*

The project will require greater front and rear yard setbacks; increase minimum lot widths; reduce the amount of lot area an individual home can occupy; clarify existing access and fence requirements; establish a new subdivision process for the adaptive reuse of existing apartment homes into individual fee simple homeownership, establish an administrative process that will effectively establish Small Lot “Design Standards;” and will clarify the intent and procedural information as it relates to the Ordinance. All future development projects to which the proposed code amendment would apply will require CEQA review, which would include an assessment of the project's' potential impacts to recreation resources.

At this time, no housing development is proposed nor would be approved as part of the amendment and no increases in land use density, intensity, or distribution would result from its adoption. As a result, no adverse impacts related to recreation services or facilities would occur.

P. *Transportation/Traffic*

The project will require greater front and rear yard setbacks; increase minimum lot widths; reduce the amount of lot area an individual home can occupy; clarify existing access and fence requirements; establish a new subdivision process for the adaptive reuse of existing apartment homes into individual fee simple homeownership, establish an administrative process that will effectively establish Small Lot "Design Standards;" and will clarify the intent and procedural information as it relates to the Ordinance. No development is proposed nor would any specific development be approved by the adoption of the proposed amendment to the Small Lot Ordinance.

With no specific development, changes in land use designation or intensity are proposed, the code amendment would not increase traffic volumes, change air traffic patterns or increase airport traffic, nor result in the construction of sharp curves, dangerous intersection or other hazardous traffic or intersections within the City of Los Angeles. No major changes in road engineering, alignment or intersection controls that could affect traffic safety are proposed and farm equipment and other incompatible vehicular or transportation uses would not be introduced or facilitated by the project. Any future development projects would be subject to individual review for potential traffic impacts and those impacts would be addressed on a case-by-case basis. The adoption of the amendment would not be expected to affect traffic or circulation within the City. No adverse impacts would result.

Q. *Utilities and Service Systems*

No specific development is proposed nor would any individual development be approved as part of the proposed code amendment. In addition, no increases in land use density, intensity, or distribution are proposed. The project would not result in a measurable increase in the demand for water nor in an increase in wastewater generation. No new or expanded wastewater facilities are proposed or would be required in order to implement the proposed code amendment. New development built subject to the proposed regulations would be subject to various water conservation measures in the citywide landscape ordinance and other regulations. All future development projects to which the proposed code amendment would apply will require CEQA review, which would include an assessment of the project's' potential impacts to utilities and service systems. As a result, no impact would result from the code amendment.

R. *Mandatory Findings of Significance*

Based on all of the above, the proposed ordinance would not substantially degrade environmental quality, substantially reduce fish or wildlife habitat, cause a fish or wildlife population to drop below self-sustaining levels, threaten to eliminate a plant or animal community, reduce the number or restrict the range of a rare or endangered plant or animal or eliminate important examples of the major periods of California history or prehistory. The project would alter the regulations applied to future applications requesting the approval of a

small lot subdivision map, only, and would not impact adopted land uses, zoning, or density. The project itself does not involve new construction, excavation, or grading, and is not growth inducing. Implementation of the proposed changes to existing small lot subdivision regulations through a future project within the City of Los Angeles would be required to be consistent with the General Plan, applicable Community Plans, and Zoning Ordinance as amended by this code amendment project. Furthermore, any new project to which the proposed code amendment would apply will require CEQA review.

As noted previously in the Exceptions to the Use of Categorical Exemptions section, and as supported in this Additional Factual Support section, the proposed ordinance amendment would not have a cumulatively considerable impact on the environment.

Prepared by:

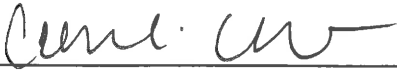

Connie Chau
City Planning Assistant

8/17/16

Date

Reviewed by:

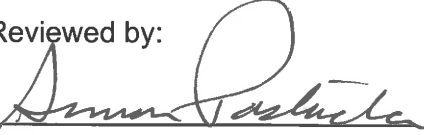

Simon Pastucha
Senior City Planner

Aug 17, 2016

Date