

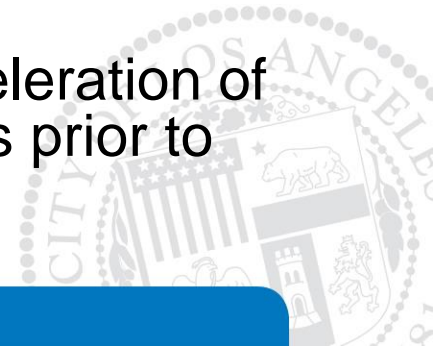

# BACKGROUND

## Recent Initiatives Related to Single-Family Scale & Character:

1. **BMO/BHO Amendment:** Citywide regulations for single-family zones (RA, RE, RS, R1).
2. **Interim Control Ordinances (ICOs):** Temporary restrictions in selected neighborhoods.
3. **New Historic Preservation Overlay Zones (HPOZs):** Establishment of historic districts to replace some ICOs prior to expiration.
4. **New R1 Zones and Rear Garage District:** Acceleration of new **re:code LA** R1 zones to replace some ICOs prior to expiration.



# BASELINE MANSIONIZATION (BMO) & BASELINE HILLSIDE (BHO) AMENDMENT

- Modify R1 building envelope:
  - Encroachment plane
  - Side wall articulation
  - Roof deck setback along side yard
- Limit R1 driveway width in non-Hillside areas
- Hillside Area only:
  - Reduce exemptions to grading & hauling limits
  - Limit hauling activities to 9 a.m. – 3 p.m., Monday-Friday
  - Reduce guaranteed minimum RFA from 1,000 to 800 SF
- Reduce Residential Floor Area (RFA) exemptions
- Reduce R1 Floor Area Ratio (FAR) to 0.45 for all lot sizes
- Eliminate all 20% RFA bonus options in R1 Zone
- Eliminate green building bonus option in RA, RE, RS Zones



# ENCROACHMENT PLANE

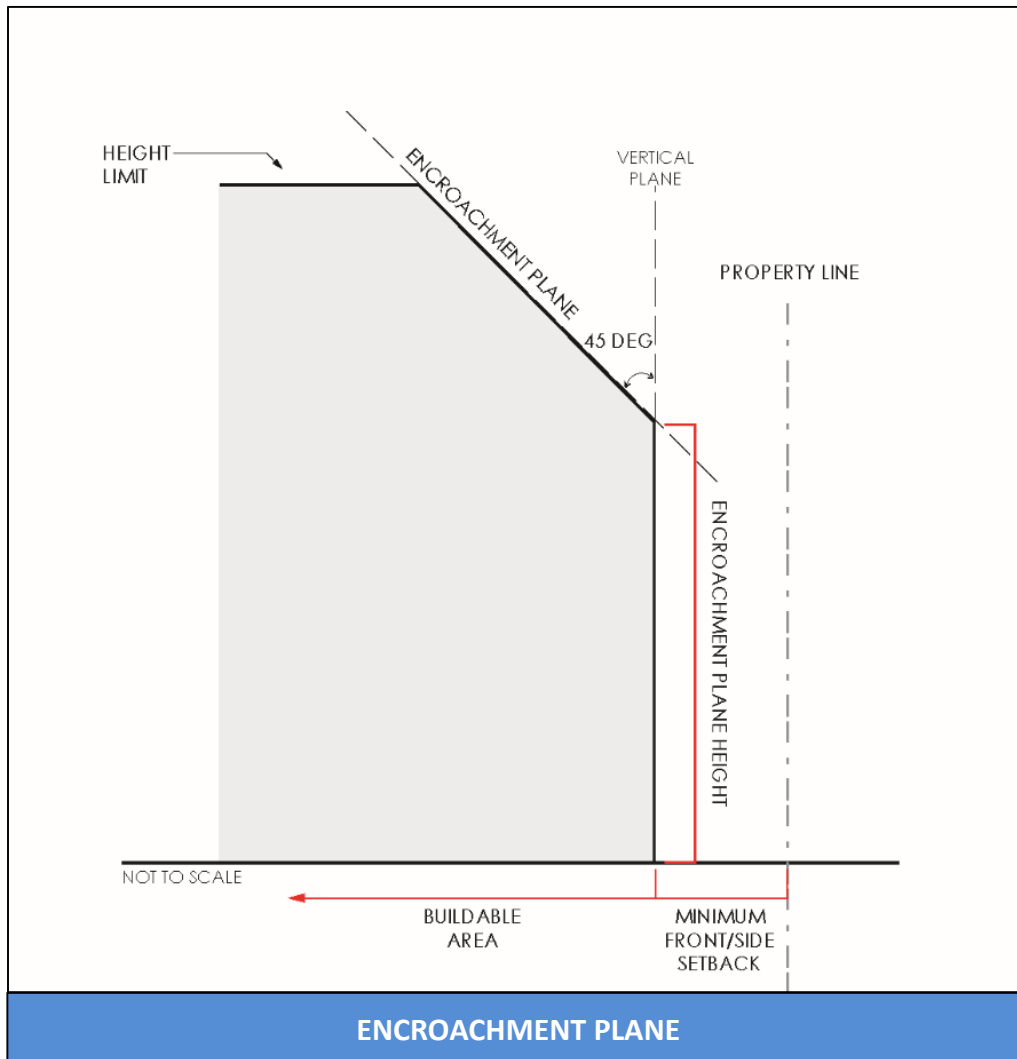

- Allows specific height at setback line
- 45° angle above said height
- Wall height measured at building perimeter



# SIDE WALL ARTICULATION

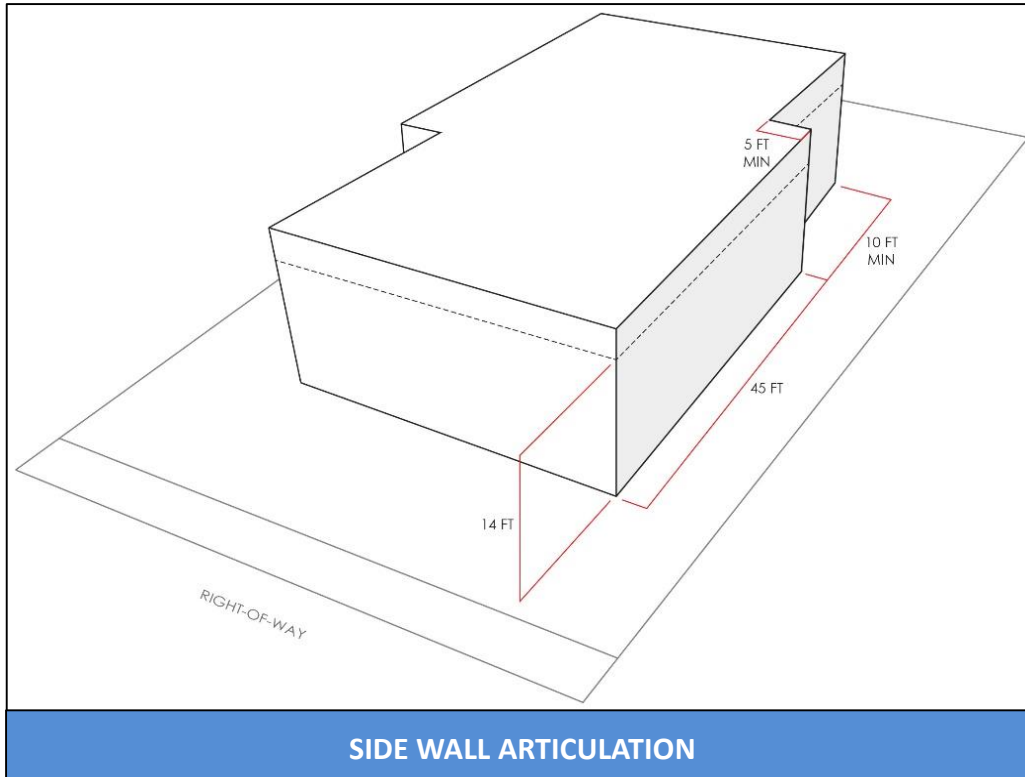

- Offset/plane break for walls over 14' high & 45' long
- At least 5' deep beyond required setback
- At least 10' long
- Wall height measured at building perimeter



# R1 VARIATION ZONES BUILD ON BMO/BHO

Create more tailored R1 regulations that calibrate the following provisions:

- Maximum Residential Floor Area Ratios based on lot size
- Maximum Height
- Encroachment Plane Starting Points
- Placement of Upper Stories (form)
- Maximum Lot Coverage

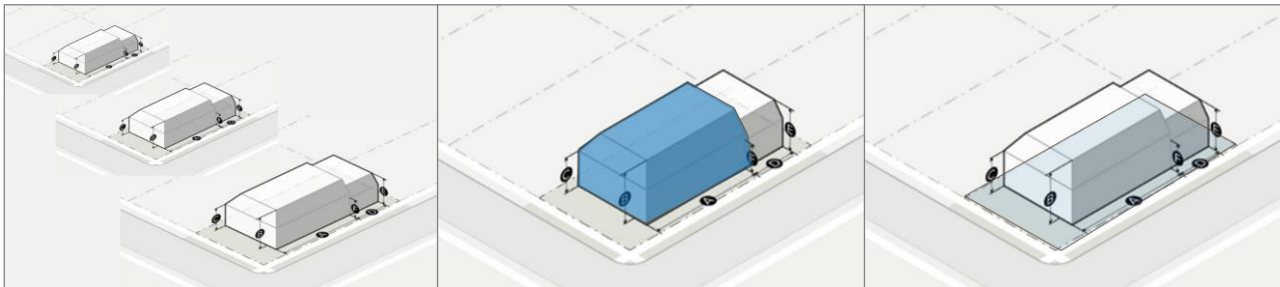

# R1 VARIATION ZONE CATEGORIES

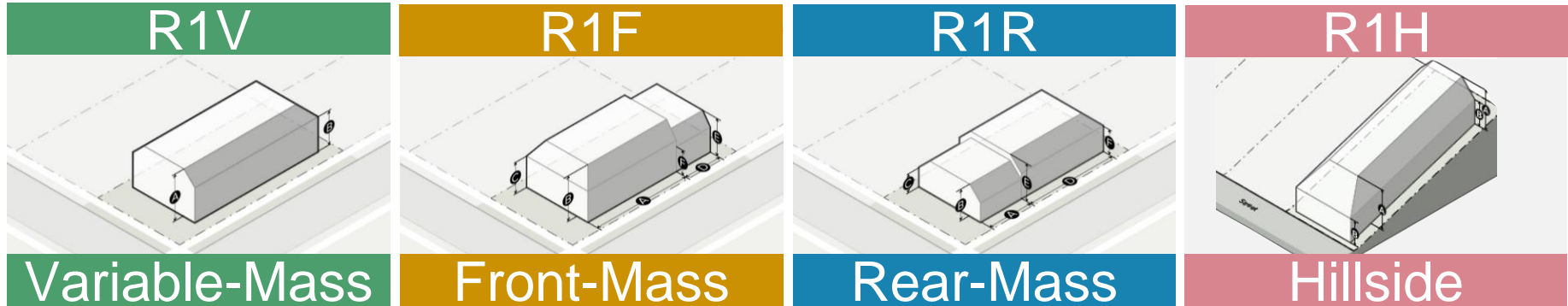

Grouped by Form



or

Designated Hillside Area



# R1 VARIATION ZONES

R1V

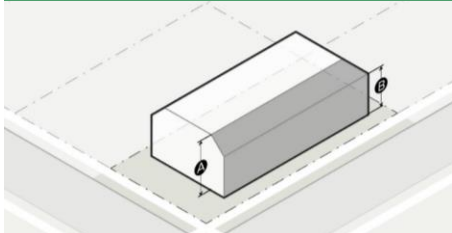

R1F

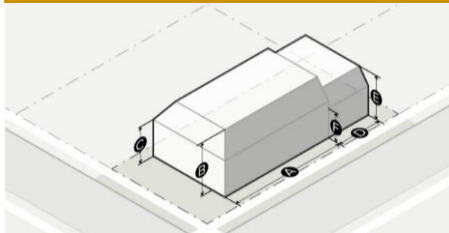

R1R

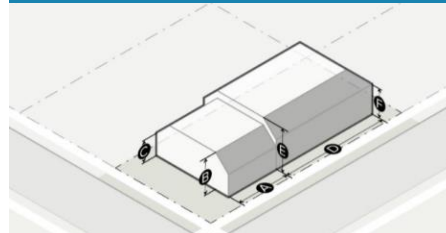

R1H

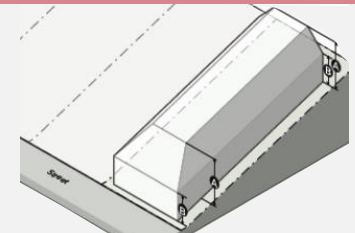

Variable-Mass

Front-Mass

Rear-Mass

Hillside

Largest



Smallest

- R1V1
- R1V2
- R1V3
- R1V4

- R1F1
- R1F2
- R1F3
- R1F4

- R1R1
- R1R2
- R1R3
- R1R4

- R1H1
- R1H2
- R1H3
- R1H4





# R1 VARIATION ZONES NAMES

R1 VARIATION ZONES NAME CHANGES		
Previous Name	Updated Name	Residential Floor Area Ratio (RFAR) Range (NO CHANGE)
<b>R1 Variable Mass Zones</b>		
R1V1	R1V1	0.65 - 0.55
R1V <b>New</b>	R1V2	0.55 - 0.45
R1V2	R1V3	0.45 - 0.35
R1V3	R1V4	0.40 - 0.30
<b>R1 Front Mass Zones</b>		
R1F1	R1F1	0.65 - 0.55
R1F <b>New</b>	R1F2	0.55 - 0.45
R1F2	R1F3	0.45 - 0.35
R1F3	R1F4	0.40 - 0.30
<b>R1 Rear Mass Zones</b>		
R1R1	R1R1	0.65 - 0.55
R1R <b>New</b>	R1R2	0.55 - 0.45
R1R2	R1R3	0.45 - 0.35
R1R3	R1R4	0.40 - 0.30
<b>R1 Hillside Zones</b>		
R1H1	R1H1	0.65 - 0.00
R1H <b>New</b>	R1H2	0.55 - 0.00
R1H2	R1H3	0.45 - 0.00
R1H3	R1H4	0.40 - 0.00

# R1V CATEGORY

## R1 VARIABLE-MASS VARIATION ZONES DEVELOPMENT STANDARDS

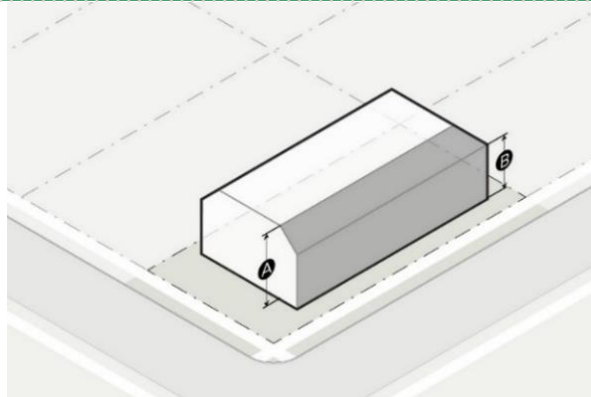

Lot Size and Residential Floor Area Ratio		R1V1	R1V2	R1V3	R1V4	Max Lot Coverage
	Up to 6,000 SF	.65	.55	.45	.40	50%
	6,001 to 7,000 SF	.63	.53	.43	.38	48%
	7,001 to 8,000 SF	.61	.51	.41	.36	46%
	8,001 to 9,000 SF	.59	.49	.39	.34	44%
	9,001 to 10,000 SF	.57	.47	.37	.32	42%
	Over 10,000 SF	.55	.45	.35	.30	40%
Mass						
(A)	Total Height (max)	30'	30'	28'	20'	
(B)	Encroachment Plane Begins (max)	22'	22'	20'	14'	
	Angle of Encroachment Plane (max)	45°	45°	45°	45°	

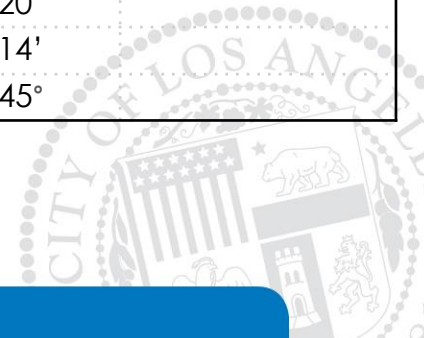

# R1F CATEGORY

## R1 FRONT-MASS VARIATION ZONES DEVELOPMENT STANDARDS



Lot Size and Residential Floor Area Ratio	R1F1	R1F2	R1F3	R1F4	Max Lot Coverage
Up to 6,000 SF	.65	.55	.45	.40	50%
6,001 to 7,000 SF	.63	.53	.43	.38	48%
7,001 to 8,000 SF	.61	.51	.41	.36	46%
8,001 to 9,000 SF	.59	.49	.39	.34	44%
9,001 to 10,000 SF	.57	.47	.37	.32	42%
Over 10,000 SF	.55	.45	.35	.30	40%
<b>Front Mass</b>					
(A) Front envelope depth, from front yard setback (min)	-	-	-	-	
(B) Total Height (max)	30'	30'	28'	26'	
(C) Encroachment Plane Begins (max)	22'	22'	20'	18'	
Angle of Encroachment Plane (max)	45°	45°	45°	45°	
<b>Rear Mass</b>					
(D) Rear envelope depth, from rear yard setback (min)	25'	25'	25'	25'	
(E) Total Height (max)	24'	24'	20'	18'	
(F) Encroachment Plane Begins (max)	16'	16'	14'	14'	
Angle of Encroachment Plane (max)	45°	45°	45°	45°	

# R1R CATEGORY

## R1 REAR-MASS VARIATION ZONES DEVELOPMENT STANDARDS

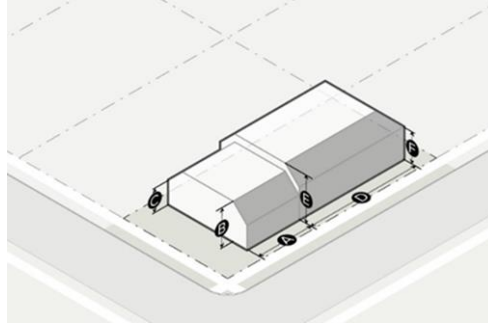

Lot Size and Residential Floor Area Ratio	R1R1	R1R2	R1R3	R1R4	Max Lot Coverage
Up to 6,000 SF	.65	.55	.45	.40	50%
6,001 to 7,000 SF	.63	.53	.43	.38	48%
7,001 to 8,000 SF	.61	.51	.41	.36	46%
8,001 to 9,000 SF	.59	.49	.39	.34	44%
9,001 to 10,000 SF	.57	.47	.37	.32	42%
Over 10,000 SF	.55	.45	.35	.30	40%
Front Mass					
(A) Front envelope depth, from front yard setback (min)	30'	30'	30'	30'	
(B) Total Height (max)	24'	24'	20'	18'	
(C) Encroachment Plane Begins (max)	16'	16'	12'	12'	
Angle of Encroachment Plane (max)	45°	45°	45°	45°	
Rear Mass					
(D) Rear envelope depth, from rear yard setback (min)	-	-	-	-	
(E) Total Height (max)	30'	30'	28'	26'	
(F) Encroachment Plane Begins (max)	22'	22'	20'	18'	
Angle of Encroachment Plane (max)	45°	45°	45°	45°	

# R1H CATEGORY

## R1H HILLSIDE VARIATION ZONES DEVELOPMENT STANDARDS

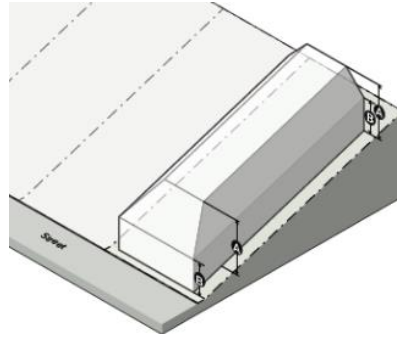

Slope Band (%)	R1H1	R1H2	R1H3	R1H4
0 – 14.99	0.65	0.55	0.45	0.40
15 – 29.99	0.60	0.50	0.45	0.35
30 – 44.99	0.55	0.45	0.40	0.30
45 – 59.99	0.50	0.40	0.35	0.25
60 – 99.99	0.45	0.35	0.30	0.20
100+	0.00	0.00	0.00	0.00



# REAR DETACHED GARAGE SUD

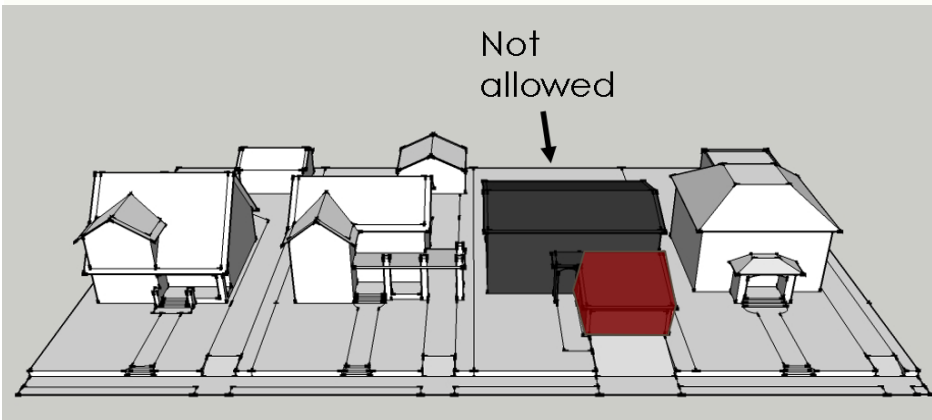
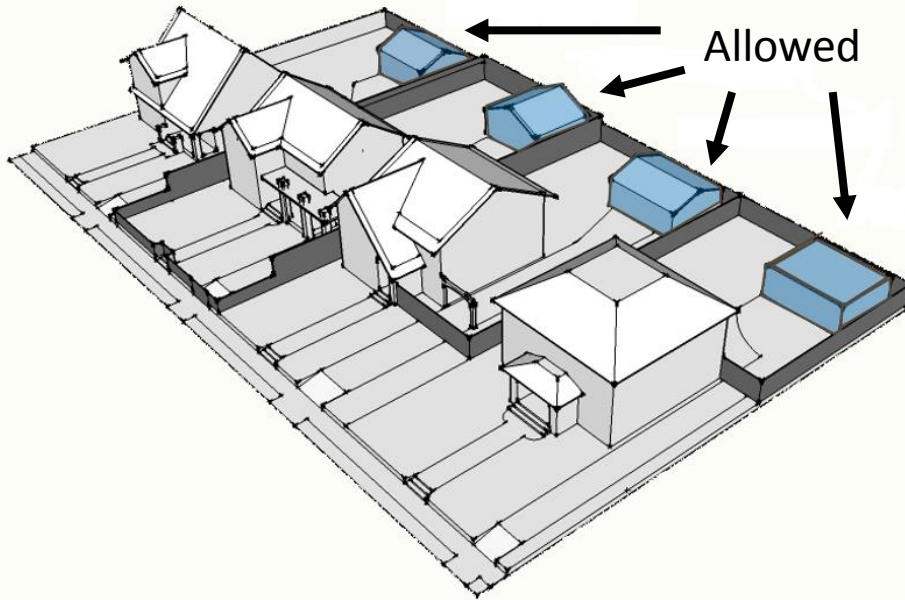

Parking requirement must:

- Be satisfied by an enclosed garage,
- Be detached, and
- Located at the rear of the lot



# PROPOSED ORDINANCE

## R1 Variation Zones

R1V

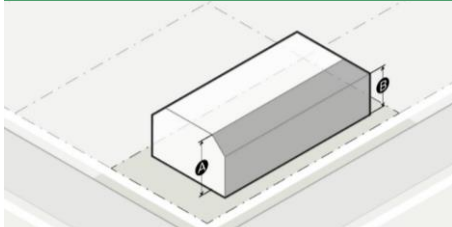

Variable-Mass

R1F

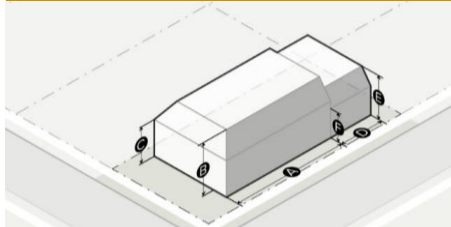

Front-Mass

R1R

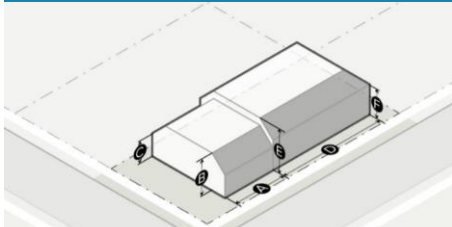

Rear-Mass

R1H

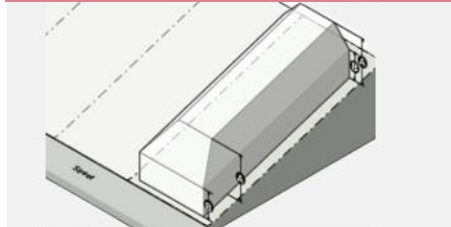

Hillside

## Rear Detached Garage Supplemental Use District

RG

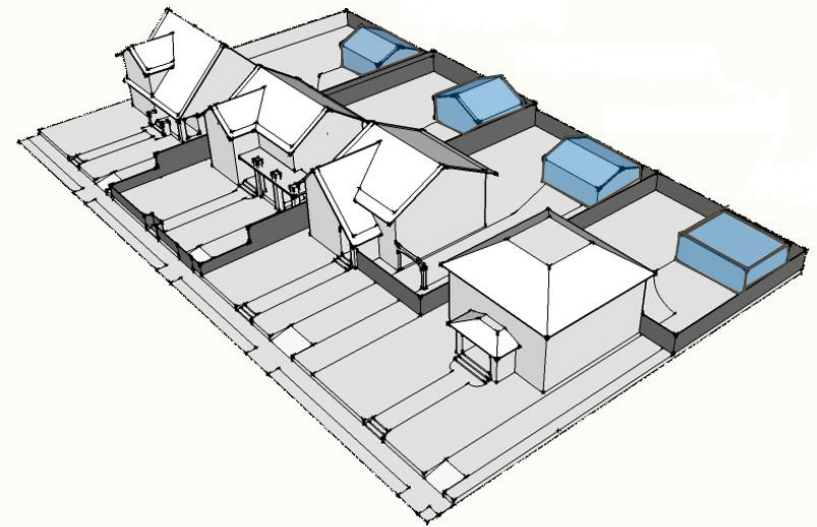

Rear Detached Garage