

ORDINANCE NO. _____

An ordinance finding that the public interest and necessity require the acquisition by eminent domain of property located at 9790 Bellanca Avenue, Los Angeles, California 90045 and bearing Assessor's Parcel Numbers 4125-026-014 and 4125-026-015.

**THE PEOPLE OF THE CITY OF LOS ANGELES
DO ORDAIN AS FOLLOWS:**

Section 1. The City Council of the City of Los Angeles hereby approves, ratifies and makes the findings and authorizations set forth in Resolution No. 26576 (Resolution) adopted by the Board of Airport Commissioners (the Board) of Los Angeles World Airports (LAWA).

Sec. 2. The City Council finds and determines that:

- a. LAWA is a proprietary department of the City of Los Angeles, a charter city and municipal corporation.
- b. The interests in real property to be acquired consist of: (a) the fee interest in the property as set forth on Exhibit A1 and Exhibit A2; (b) a permanent wall footing easement as set forth on Exhibit B, Exhibit B1 and Exhibit B2; and (c) a temporary construction easement as set forth on Exhibit C, Exhibit C1 and Exhibit C2. Collectively, all interests in real property to be acquired are referred to as the "Subject Property." The Subject Property is located within the City of Los Angeles, County of Los Angeles, State of California.
- c. The public use for which the Subject Property is being acquired is the Landside Access Modernization Program, a public project designed to improve and modernize access to the Los Angeles International Airport (Project).
- d. Pursuant to Code of Civil Procedure Sections 1240.610 and 1240.510, to the extent that the Subject Property is already devoted to a public use, the use to which the Subject Property is to be acquired under the Resolution is a more necessary public use than the use to which the Subject Property is already devoted; or, in the alternative, is a compatible public use which will not unreasonably interfere with or impair the continuance of the public use to which the Subject Property is already devoted.
- e. The notice of intention to approve the Resolution was given by first class mail to the persons whose property is to be acquired by eminent domain in accordance with Code of Civil Procedure Section 1245.235, and a hearing was conducted by the City Council on the matters contained herein.

Sec. 3. The City Council further finds and determines that:

- a. The environmental impacts of the Project were evaluated in the previously adopted LAMP EIR, ENV-2016-3391-EIR. The LAMP EIR was adopted by the Board on March 2, 2017 (Resolution No. 26185), and certified and adopted by the Los Angeles City Council on June 7, 2017. The acquisition of the Subject Property is exempt from the requirements of the California Environmental Quality Act (CEQA) pursuant to Article II, Section 2.i of the Los Angeles City CEQA Guidelines. It is also within the scope of the certified LAMP EIR and does not include any changes to the Project that would require further review under CEQA pursuant to Public Resources Code Section 21166 and CEQA Guidelines Section 15162.
- b. The taking of the Subject Property is authorized by, *inter alia*, Section 19, Article I of the California Constitution; Sections 37350.5 and 40404(f) of the California Government Code; Public Utilities Code Section 21661.6; the Los Angeles City Charter Section 632(c); California Code of Civil Procedure Section 1230.010, et seq.; and all other applicable law as set forth herein.

Sec. 4. The City Council further finds and determines that:

- a. The public interest and necessity require the Project.
- b. The Project is planned or located in the manner that will be most compatible with the greatest public good and the least private injury.
- c. The Subject Property sought to be acquired by eminent domain and described in the Resolution is necessary for the proposed Project.
- d. The offer required by Government Code Section 7267.2(a), together with the accompanying statement and summary of the basis for the amount established as just compensation, was actually made to the owners and was in a form and contained all of the factual information required by Government Code Section 7267.2(a).
- e. The requisite environmental review of the Project and the acquisition of the Subject Property have been completed in accordance with CEQA.

Sec. 5. The City Council approves the Resolution and the exercise of eminent domain by LAWA in accordance with Charter Section 632(c).

Sec. 6. The City Attorney is hereby authorized and directed to take all steps necessary to commence legal proceedings, in a court of competent jurisdiction, to acquire the Subject Property by eminent domain, subject to approval by the Board when required. The City Attorney is also authorized to seek and obtain an Order for

Prejudgment of Possession of the Subject Property in accordance with eminent domain law. The City Attorney may enter into Stipulated Orders for Prejudgment Possession and Possession and Use Agreements, where such agreements constitute the functional equivalent of an Order for Prejudgment Possession. The City Attorney is further authorized to correct any errors or agree to make any non-material changes to the legal description of the Subject Property that are deemed necessary for the conduct of condemnation action or other proceedings or transactions required to acquire the Subject Property. The City Attorney is further authorized, subject to approval by the Board when required, to compromise and settle such eminent domain proceedings, if such negotiated settlement can be reached, and in that event, take all necessary action to complete the acquisition, including entering into stipulations as to the judgment and other matters, and to cause all such payments to be made.

Sec. 7. The Chief Financial Officer of LAWA, upon proper certification and instruction from the Chief Executive Officer and City Attorney, is authorized and directed to draw demands in the amounts necessary to make deposits of just compensation with the California State Treasurer's Office in connection with the eminent domain proceedings and/or pay the purchase price for the acquisition of the Subject Property through negotiated settlement or court judgment.

EXHIBIT "A1"
LEGAL DESCRIPTION
FEE SIMPLE INTEREST

A PORTION OF LOT 1 AND A PORTION OF BELLANCA AVENUE OF TRACT NO. 13375 IN THE CITY AND COUNTY OF LOS ANGELES, STATE OF CALIFORNIA, AS THE SAME IS SHOWN ON THE MAP FILED AUGUST 22, 1945 IN MAP BOOK 267, PAGES 43 AND 44 IN THE OFFICE OF SAID COUNTY RECORDER, BEING MORE PARTICULARLY DESCRIBED AS FOLLOWS:

BEGINNING AT THE INTERSECTION OF THE CENTERLINE OF SAID BELLANCA AVENUE AND THE WESTERLY PROLONGATION OF THE SOUTH LINE OF SAID LOT 1;

THENCE, ALONG SAID CENTERLINE NORTH 00°09'57" EAST 65.96 FEET;

THENCE, DEPARTING SAID CENTERLINE SOUTH 89°50'03" EAST 43.00 FEET;

THENCE, SOUTH 42°30'46" EAST 35.74 FEET TO THE BEGINNING OF A NON-TANGENT CURVE CONCAVE TO THE SOUTHWEST;

THENCE, SOUTHEASTERLY FROM A TANGENT WHICH BEARS SOUTH 85°40'28" EAST, ALONG A CURVE TO THE RIGHT, HAVING A RADIUS OF 882.00 FEET, THROUGH A CENTRAL ANGLE OF 13°36'39" AN ARC LENGTH OF 209.52 FEET TO THE SOUTH LINE OF SAID LOT 1;

THENCE, ALONG THE SOUTH LINE OF SAID LOT 1, NORTH 89°49'05" WEST 272.44 FEET TO THE **POINT OF BEGINNING**.

CONTAINING 0.208 ACRES OR 9,060 SQUARE FEET, MORE OR LESS.

BEARINGS AND DISTANCES ARE BASED ON CCS83, ZONE 5 (2010.00). THE DISTANCES SHOWN HEREIN ARE GRID DISTANCES. GROUND DISTANCES MAY BE OBTAINED BY DIVIDING GRID DISTANCES BY THE COMBINATION FACTOR OF 1.00001967.

SEE PLAT ATTACHED HERETO AS EXHIBIT "A2" AND BY THIS REFERENCE MADE PART HEREOF.

PREPARED UNDER MY SUPERVISION:



LINWOOD CARLETON, JR., P.L.S.
P.L.S. 6594, EXP. 12-31-19

04-11-18
DATE

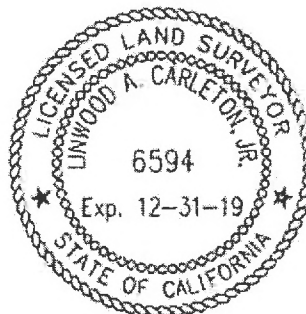
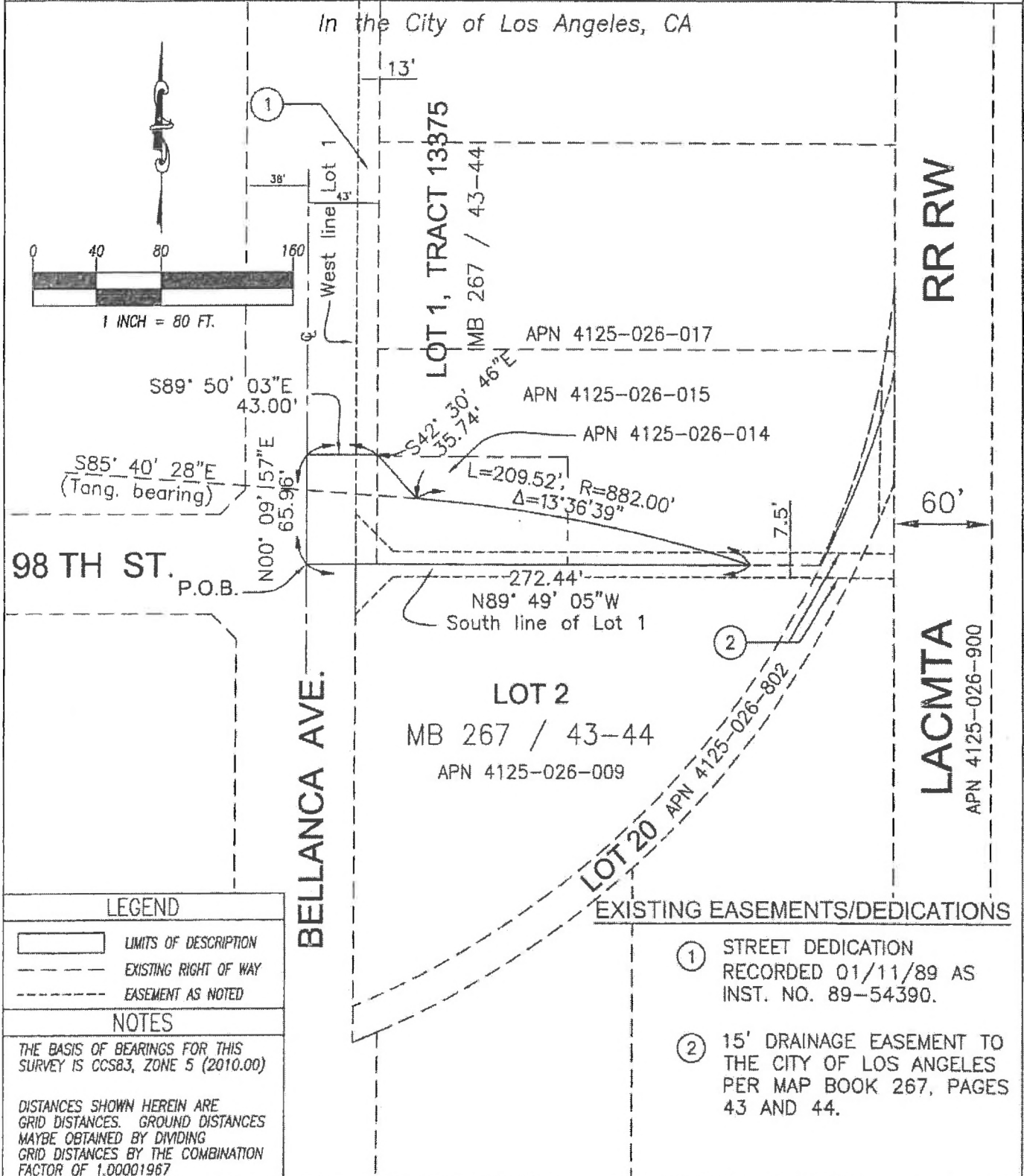

EXHIBIT A2

PARCEL #	TITLE	AREA	APN
4-13, 14	FEE	9,060 SF	4125-026-014, 015



	DATE	REV. #	PREPARED BY	SHEET NO.	TOTAL SHEETS
	04-11-18	0	LC	1	1

Overland, Pacific and Cutler, Inc.
3750 Schoufele Ave, Suite 150
Long Beach, CA 90808
Ph: 562-304-2000

EXHIBIT "B" – Permanent Wall Footing Easement

RECORDING REQUESTED BY and WHEN RECORDED MAIL TO:

Los Angeles World Airports
Attn: Marisa Katnich
6053 West Century Boulevard, 4th Floor
Los Angeles, California 90045

(Space above for County Recorder's Use Only)

Portions APN(s): 4125-026-014
4125-026-015

EXEMPT FROM RECORDING FEES PER GOVT. CODE §27383
EXEMPT FROM DOCUMENTARY TRANSFER TAX PER REV. & TAX CODE §11922

EASEMENT DEED

Grant of Permanent and Non-Exclusive Wall Footing Easement

FOR GOOD AND VALUABLE CONSIDERATION, the receipt and sufficiency of which is hereby acknowledged, Sandra Amburgey, Robert Hutting, Jr., Trustee of the Hutting Family Trust, and Anna M. Hutting, Trustee of the Hutting Family Trust (collectively, "**Grantors**") do hereby GRANT and CONVEY to the City of Los Angeles, a municipal corporation, acting by order of and through its Board of Airport Commissioners ("**Grantee**"), and its successors and assigns, a permanent and non-exclusive wall footing easement ("**Wall Footing Easement**"), over, above, on, under, in, across, along and through that certain portion of Grantor's real property located in the City of Los Angeles, County of Los Angeles, State of California, more particularly described in the legal description attached hereto as EXHIBIT "B1" and depicted or illustrated on the map or drawing attached hereto as EXHIBIT "B2" and incorporated herein by reference ("**Easement Area**"), for the purpose of all necessary and convenient activities associated with the construction of the Landside Access Modernization Program ("**Project**").

Within the Easement Area, the easement rights granted in, under and pursuant to this instrument shall include the right to use the Wall Footing Easement to construct, use, maintain, repair, replace, improve, alter, relocate, and inspect footing and appurtenances of a retaining wall that will be constructed by Grantee within property being acquired in fee by Grantee, and located adjacent and contiguous to the Easement Area.

The Easement rights granted in, under and pursuant to this instrument and the rights of Grantee in, under and pursuant to this instrument shall include without limitation the right to reasonably access the Easement Area for all purposes associated with the Wall Footing Easement, which activities may include, but are not be limited to, trimming, cutting or clearing away from the Easement Area any trees, brush, and vegetation. In addition, Grantee shall have the right in its sole and absolute discretion to remove improvements within the Easement Area without payment of additional compensation. However, Grantee shall restore and/or replace any and all curb, gutter, hardscape and landscaping improvements that it removes.

EXHIBIT "B" – Permanent Wall Footing Easement

The Wall Footing Easement shall impose the following restriction on the Grantor and its heirs, assigns and successors, including Grantor's land/real property of which the Easement Area is part (and, as such, the restriction shall run with the land): Grantor, its heirs, assigns, and successors shall not erect or construct or permit to be erected or constructed, any building, structure, or vertical improvement on, over, or under any portion of the Easement Area without the written consent of Grantee, its successors, and assigns. Absent written consent of Grantee, Grantor may solely improve the Easement Area with curbs, gutters, hardscaping and/or landscaping.

Grantee shall have the right to transfer, assign and/or convey the Wall Footing Easement, including without limitation any interest therein and/or in whole or in part, to successors and/or assigns, including without limitation other governmental agencies.

The covenants contained in this Instrument, including without limitation any restrictions set forth above, shall run with the land.

IN WITNESS WHEREOF, Grantor has caused this Instrument to be executed on the date set forth below.

Dated: _____

GRANTOR:

SANDRA AMBURGEY

By: _____

Name: _____

Title: _____

Dated: _____

GRANTOR:

THE HUTTING FAMILY TRUST

By: _____

Name: Robert Hutting, Jr.

Title: Trustee

EXHIBIT "B" – Permanent Wall Footing Easement

Dated: _____

GRANTOR:

THE HUTTING FAMILY TRUST

By: _____

Name: Anna M. Hutting

Title: Trustee

EXHIBIT "B1"

Legal Description of Wall Footing Easement Area
[APN(s): 4125-026-014 and 4125-026-015]

[attached behind this page]

EXHIBIT "B1"
LEGAL DESCRIPTION
PERMANENT WALL FOOTING EASEMENT

A PORTION OF LOT 1 OF TRACT NO. 13375 IN THE CITY AND COUNTY OF LOS ANGELES, STATE OF CALIFORNIA, AS THE SAME IS SHOWN ON THE MAP FILED AUGUST 22, 1945 IN MAP BOOK 267, PAGES 43 AND 44 IN THE OFFICE OF SAID COUNTY RECORDER, BEING MORE PARTICULARLY DESCRIBED AS FOLLOWS:

COMMENCING FOR A TIE AT THE SOUTHWEST CORNER OF SAID LOT 1;

THENCE, ALONG THE SOUTH LINE OF LOT 1 SOUTH 89°49'05" EAST 13.00 FEET;

THENCE, DEPARTING SAID SOUTH LINE, ALONG A LINE PARALLEL WITH AND 13.00 FEET EASTERLY OF THE WEST LINE OF SAID LOT 1, NORTH 00°09'57" EAST 65.97 FEET TO THE **POINT OF BEGINNING** AND THE SOUTHWESTERNMOST CORNER OF THE PARCEL HEREIN DESCRIBED;

THENCE, FROM THE **POINT OF BEGINNING**, CONTINUING ALONG SAID PARALLEL LINE, NORTH 00°09'57" EAST 4.43 FEET;

THENCE, SOUTH 42°30'46" EAST 37.81 FEET TO THE BEGINNING OF A NON-TANGENT CURVE;

THENCE, SOUTHEASTERLY FROM A TANGENT WHICH BEARS SOUTH 85°35'52" EAST, ALONG A CURVE TO THE RIGHT, HAVING A RADIUS OF 885.00 FEET, THROUGH A CENTRAL ANGLE OF 14°07'51" AN ARC LENGTH OF 218.27 FEET TO THE SOUTH LINE OF SAID LOT 1;

THENCE, ALONG THE SOUTH LINE OF SAID LOT 1, NORTH 89°49'05" WEST 9.68 FEET TO THE BEGINNING OF A NON-TANGENT CURVE;

THENCE, DEPARTING SAID SOUTH LINE, NORTHWESTERLY FROM A TANGENT WHICH BEARS NORTH 72°03'50" WEST, ALONG A CURVE TO THE LEFT, HAVING A RADIUS OF 882.00 FEET, THROUGH A CENTRAL ANGLE OF 13°36'39" AN ARC LENGTH OF 209.52 FEET;

THENCE, NON-TANGENT TO THE PREVIOUS CURVE, NORTH 42°30'46" WEST 35.74 FEET TO THE **POINT OF BEGINNING**.

CONTAINING 0.017 ACRES OR 755 SQUARE FEET, MORE OR LESS.

BEARINGS AND DISTANCES ARE BASED ON CCS83, ZONE 5 (2010.00). THE DISTANCES SHOWN HEREIN ARE GRID DISTANCES. GROUND DISTANCES MAY BE OBTAINED BY DIVIDING GRID DISTANCES BY THE COMBINATION FACTOR OF 1.00001967.

SEE PLAT ATTACHED HERETO AS EXHIBIT "B2" AND BY THIS REFERENCE MADE PART HEREOF.

PREPARED UNDER MY SUPERVISION:



LINWOOD CARLETON, JR., P.L.S.
P.L.S. 6594, EXP. 12-31-17

04-11-18
DATE



EXHIBIT "B2"

Map of Wall Footing Easement Area
[APN(s): 4125-026-014 and 4125-026-015]

[attached behind this page]

EXHIBIT B2

PARCEL #	TITLE	AREA	APN
4-13, 14	PERMANENT WALL FOOTING EASEMENT	755 SF	4125-026-014, 015

In the City of Los Angeles, CA

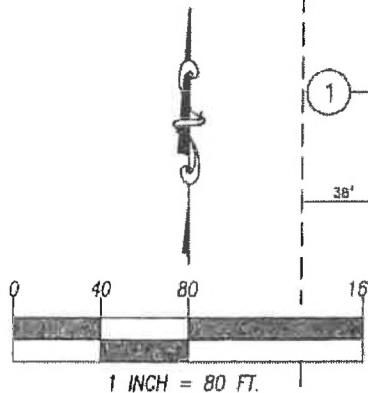

Line Table		
Line #	Length	Direction
L1	4.43'	N0° 09' 57"E
L2	35.74'	N42° 30' 46"W
L3	9.68'	N89° 49' 05"W
L4	37.81'	S42° 30' 46"E

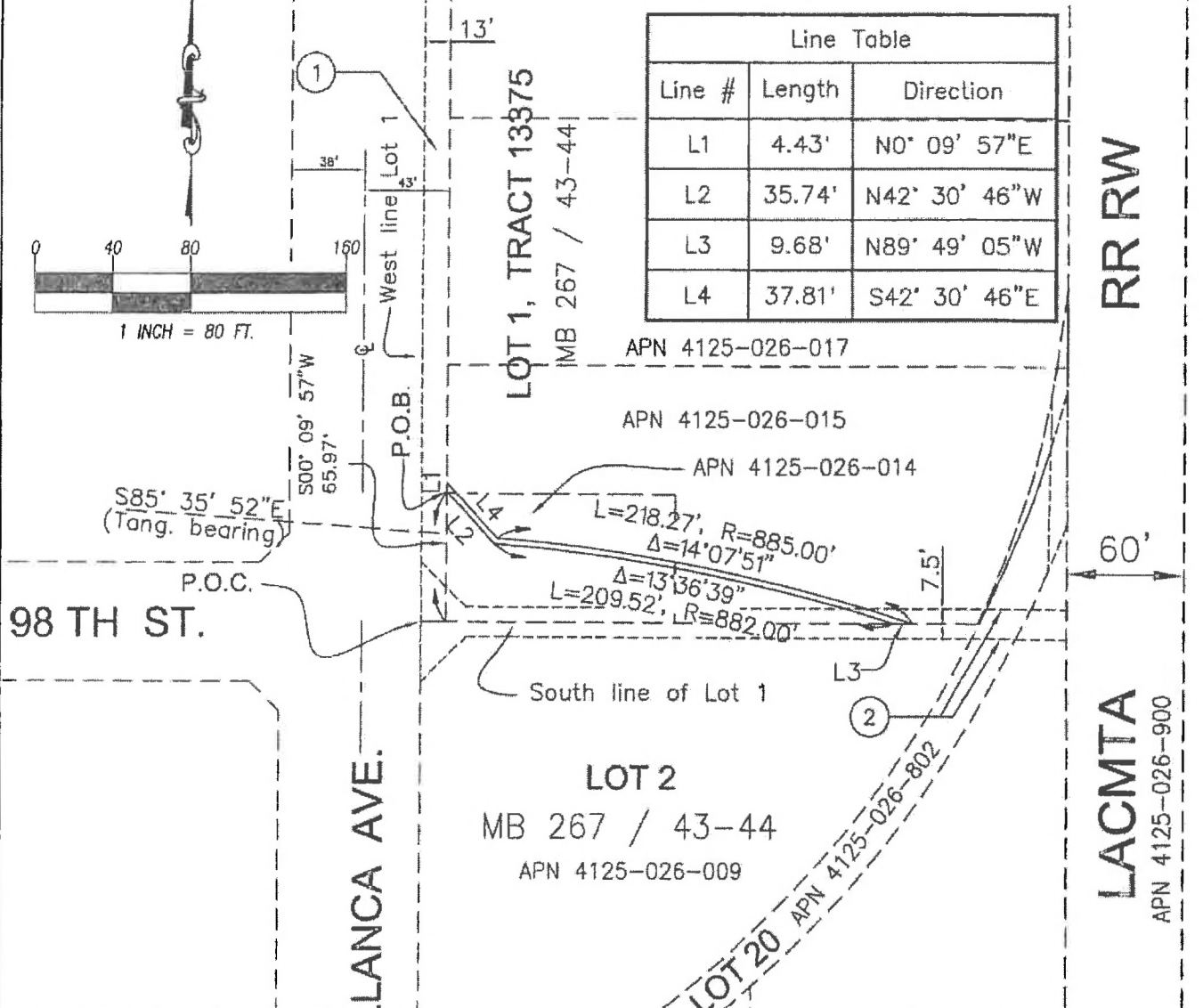

LEGEND	
	LIMITS OF DESCRIPTION
	EXISTING RIGHT OF WAY
	EASEMENT AS NOTED

NOTES

THE BASIS OF BEARINGS FOR THIS SURVEY IS CGSB3, ZONE 5 (2010.00)

DISTANCES SHOWN HEREIN ARE GRID DISTANCES. GROUND DISTANCES MAYBE OBTAINED BY DIVIDING GRID DISTANCES BY THE COMBINATION FACTOR OF 1.00001967

EXISTING EASEMENTS/DEDICATIONS

- ① STREET DEDICATION RECORDED 01/11/89 AS INST. NO. 89-54390.
- ② 15' DRAINAGE EASEMENT TO THE CITY OF LOS ANGELES PER MAP BOOK 267, PAGES 43 AND 44.

	DATE	REV. #	PREPARED BY	SHEET NO.	TOTAL SHEETS
	04-11-18	0	LC	1	1

Overland Pacific and Cutler, Inc.
 3750 Schauffele Ave, Suite 150
 Long Beach, CA 90808
 Ph: 562-304-2000

EXHIBIT "C" – Temporary Construction Easement

RECORDING REQUESTED BY and WHEN RECORDED MAIL TO:

Los Angeles World Airports
Attn: Marisa Katnich
6053 West Century Boulevard, 4th Floor
Los Angeles, California 90045

(Space above for County Recorder's Use Only)

Portions APN(s): 4125-026-014
4125-026-015

EXEMPT FROM RECORDING FEES PER GOVT. CODE §27383
EXEMPT FROM DOCUMENTARY TRANSFER TAX PER REV. & TAX CODE §11922

EASEMENT DEED

Grant of Temporary Construction Easement

FOR GOOD AND VALUABLE CONSIDERATION, the receipt and sufficiency of which is hereby acknowledged, Sandra Amburgey, Robert Hutting, Jr., Trustee of the Hutting Family Trust, and Anna M. Hutting, Trustee of the Hutting Family Trust (collectively, "**Grantors**") do hereby GRANT and CONVEY to the City of Los Angeles, a municipal corporation, acting by order of and through its Board of Airport Commissioners ("**Grantee**"), and its successors and assigns, a temporary and exclusive construction easement ("**Temporary Construction Easement**"), over, above, on, under, in, across, along and through that certain portion of Grantor's real property located in the City of Los Angeles, County of Los Angeles, State of California, more particularly described in the legal description attached hereto as EXHIBIT "C1" and depicted or illustrated on the map or drawing attached hereto as EXHIBIT "C2" and incorporated herein by reference ("**TCE Area**"), for the purpose of all necessary and convenient activities associated with the construction of the Landside Access Modernization Program ("**Project**").

The purpose of the Temporary Construction Easement includes without limitation the provision of working space for the grading and excavation associated with retaining wall, curb, gutter, sidewalk, drainage, landscaping and striping improvements. The retaining wall, curb, gutter, sidewalk, and drainage improvements will all be located adjacent to Grantor's real property and within property that will be acquired by Grantee.

The Temporary Construction Easement shall continue for a period of twenty-four (24) months. Construction within the TCE Area and the term of the Temporary Construction Easement shall commence seven (7) days from the date upon which Grantee or its authorized representative provides Grantor with written notice of Grantee's intent to commence utilization of the Temporary Construction Easement and, unless extended, it shall terminate on the earliest of (a) the date upon which Grantee notifies Grantor that it no longer needs the Temporary Construction Easement, (b) twenty-four (24) months from the commencement date of the Temporary Construction Easement, or (c) January 31, 2021 ("**Expiration Date**").

EXHIBIT "C" – Temporary Construction Easement

Grantee's use of the Temporary Construction Easement shall be subject to the following provisions: (a) during construction, reasonable vehicular and pedestrian access, including fire and other emergency access to the property, will be maintained at all times; (b) the TCE Area will be protected, maintained and kept reasonably free of trash and loose debris during construction to attempt to ensure that the visual identity and character of the adjacent property is not impacted by the construction activities within the TCE Area; (c) a six-foot high temporary fence will be erected during construction and maintained; (d) subject to the direction of the County of Los Angeles, an existing 108-inch RCP storm drain shall either be appropriately abandoned in place or appropriately removed by Grantee; and (e) while on the TCE Area, Grantee will comply with all applicable laws, rules, and regulations as well as, to the extent commercially reasonable and practicable, best construction practices, including compliance with City of Los Angeles Noise Ordinance requirements.

Prior to the Expiration Date, Grantor shall not, without the express prior written consent of Grantee (which may be granted or withheld in Grantee's sole and unfettered discretion), erect, place, or maintain any improvement, or undertake any other activity, over, above, on, under, in, across, along, through or about the TCE Area or which may interfere with Grantee's use of the TCE Area, including, without limitation, the erection of any building, wall, fence, structure or other improvement within the TCE Area.

Prior to the Expiration Date, Grantor shall also not grant or dedicate any easement, right or other interest in, to, on, under or over the TCE Area without obtaining the prior written consent of Grantee, which may be granted or withheld in Grantee's sole and unfettered discretion.

At the expiration of the Temporary Construction Easement, Grantee or its authorized agent(s) shall, subject to reasonable wear and tear, restore the TCE Area to a condition as near as practicable to finished dirt grade conditions with surface elevations consistent with the existing grading of the surface parking area immediately adjacent to the TCE Area. The restoration shall also include return to natural grade, the installation of a permanent PCC driveway approach, and the installation of an 18-inch diameter RCP storm drain pipe. Grantee shall not, however, be required to restore any other changed condition or circumstance not resulting from Grantee's operations, negligence or grater fault, to the pre-existing condition.

EXHIBIT "C" – Temporary Construction Easement

The covenants contained in this Instrument shall run with the land.

IN WITNESS WHEREOF, Grantor has caused this Instrument to be executed on the date set forth below.

Dated: _____

GRANTOR:

SANDRA AMBURGEY

By: _____

Name: _____

Title: _____

Dated: _____

GRANTOR:

THE HUTTING FAMILY TRUST

By: _____

Name: Robert Hutting, Jr.

Title: Trustee

Dated: _____

GRANTOR:

THE HUTTING FAMILY TRUST

By: _____

Name: Anna M. Hutting

Title: Trustee

EXHIBIT "C1"

Legal Description of Temporary Construction Easement Area
[APN(s): 4125-026-014 and 4125-026-015]

[attached behind this page]

EXHIBIT "C1"
LEGAL DESCRIPTION
TEMPORARY CONSTRUCTION EASEMENT

A PORTION OF LOT 1 OF TRACT NUMBER 13375 IN THE CITY AND COUNTY OF LOS ANGELES, STATE OF CALIFORNIA, AS THE SAME IS SHOWN ON THE MAP FILED AUGUST 22, 1945 IN MAP BOOK 267, PAGES 43 AND 44 IN THE OFFICE OF SAID COUNTY RECORDER, BEING MORE PARTICULARLY DESCRIBED AS FOLLOWS:

COMMENCING FOR A TIE AT THE SOUTHWEST CORNER OF SAID LOT 1;

THENCE, ALONG THE SOUTH LINE OF SAID LOT 1 SOUTH 89°49'05" EAST 13.00 FEET;

THENCE, DEPARTING SAID SOUTH LINE, ALONG A LINE PARALLEL WITH AND 13.00 FEET EASTERLY OF THE WEST LINE OF SAID LOT 1, NORTH 0°09'57" EAST 70.40 FEET TO THE **POINT OF BEGINNING** AND THE SOUTHWESTERNMOST CORNER OF THE PARCEL HEREIN DESCRIBED;

THENCE, FROM THE **POINT OF BEGINNING**, CONTINUING WITH SAID PARALLEL LINE, NORTH 0°09'57" EAST 5.90 FEET;

THENCE, SOUTH 42°30'46" EAST 40.57 FEET TO THE BEGINNING OF A NON-TANGENT CURVE;

THENCE, SOUTHEASTERLY FROM A TANGENT WHICH BEARS SOUTH 85°29'45" EAST, ALONG A CURVE TO THE SOUTHEAST, HAVING A RADIUS OF 889.00 FEET, THROUGH A CENTRAL ANGLE OF 9°01'24", AN ARC LENGTH OF 140.01 FEET TO A LINE PARALLEL WITH AND 25.00 FEET NORTHERLY OF THE SOUTH LINE OF SAID LOT 1;

THENCE, ALONG SAID PARALLEL LINE, SOUTH 89°49'05" EAST 117.84 FEET TO A POINT ON THE WEST LINE OF THAT REAL PROPERTY DESCRIBED AS PARCEL 1B OF THE GRANT DEED TO MARCO NASER KHORASANI AND NICOLE J. KHORASANI RECORDED OCTOBER 29, 1999 AS DOCUMENT NUMBER 99-2039029 OF OFFICIAL RECORDS OF SAID COUNTY, SAID WESTERLY LINE IS ALSO A NON-TANGENT CURVE CONCAVE WESTERLY AND HAVING A RADIUS OF 486.35 FEET, TO WHICH A RADIAL BEARS THROUGH SAID POINT SOUTH 67°55'16" EAST;

THENCE SOUTHWESTERLY ALONG SAID WESTERLY LINE OF PARCEL 1B, THROUGH A CENTRAL ANGLE OF 3°20'14", AN ARC DISTANCE OF 27.28' FEET TO A POINT ON THE SOUTH LINE OF SAID LOT 1;

THENCE, ALONG THE SOUTH LINE OF SAID LOT 1 NORTH 89°49'05" WEST 33.51 FEET TO THE BEGINNING OF A NON-TANGENT CURVE;

THENCE, NORTHWESTERLY FROM A TANGENT WHICH BEARS NORTH 71°28'01" WEST, ALONG A CURVE TO THE NORTHWEST, HAVING A RADIUS OF 885.00 FEET, THROUGH A CENTRAL ANGLE OF 14°07'51", AN ARC LENGTH OF 218.27 FEET;

THENCE, NORTH 42°30'46" EAST 37.81 FEET TO THE **POINT OF BEGINNING**.

CONTAINING 0.063 ACRES OR 2,726 SQUARE FEET, MORE OR LESS.

BEARINGS AND DISTANCES ARE BASED ON THE CALIFORNIA COORDINATE SYSTEM OF 1983 (CCS83), 2010.00 EPOCH, ZONE 5. THE DISTANCES SHOWN HEREIN ARE GRID DISTANCES. GROUND DISTANCES MAY BE OBTAINED BY DIVIDING GRID DISTANCES BY THE COMBINATION FACTOR OF 1.00001967.

SEE PLAT ATTACHED HERETO AS EXHIBIT "C2" AND BY THIS REFERENCE MADE PART HEREOF.

PREPARED UNDER MY SUPERVISION:



JOSHUA D. COSPER, P.L.S.
P.L.S. 8774, EXP. 12-31-18

7-24-18
DATE



EXHIBIT "C2"

Map of Temporary Construction Easement Area
[APN(s): 4125-026-014 and 4125-026-015]

[attached behind this page]

EXHIBIT C2

PARCEL #	TITLE	AREA	APN
4-13, 14	TEMPORARY CONSTRUCTION EASEMENT	2,726 SF	4125-026-014, 015

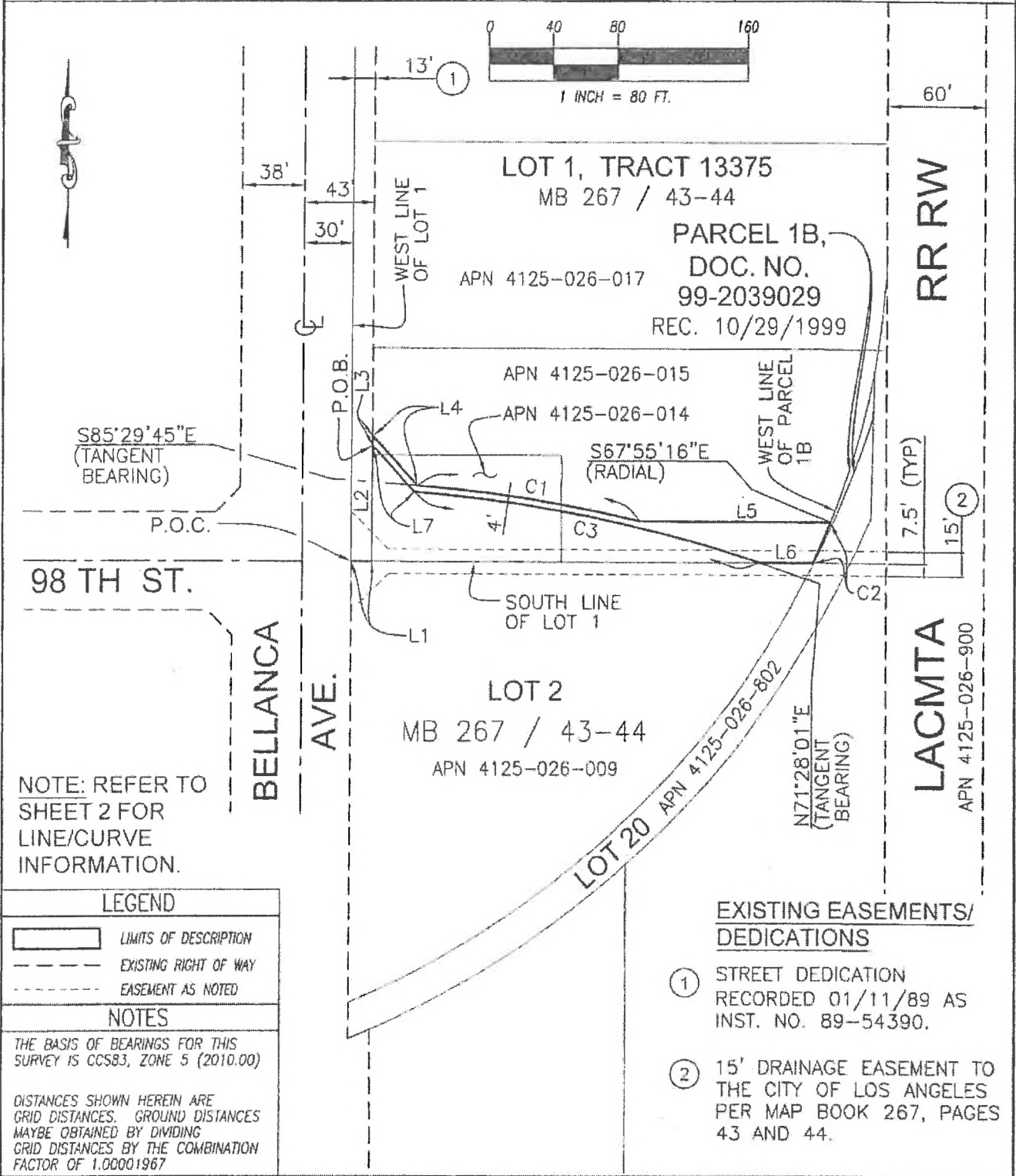

NOTE: REFER TO SHEET 2 FOR LINE/CURVE INFORMATION.

LEGEND

- LIMITS OF DESCRIPTION
- EXISTING RIGHT OF WAY
- EASEMENT AS NOTED

NOTES

THE BASIS OF BEARINGS FOR THIS SURVEY IS CCS83, ZONE 5 (2010.00)

DISTANCES SHOWN HEREIN ARE GRID DISTANCES. GROUND DISTANCES MAYBE OBTAINED BY DIVIDING GRID DISTANCES BY THE COMBINATION FACTOR OF 1.00001967

EXISTING EASEMENTS/DEDICATIONS

- ① STREET DEDICATION RECORDED 01/11/89 AS INST. NO. 89-54390.
- ② 15' DRAINAGE EASEMENT TO THE CITY OF LOS ANGELES PER MAP BOOK 267, PAGES 43 AND 44.

	Overland, Pacific and Cutler, Inc. 3750 Schauffels Ave., Suite 150 Long Beach, CA 90804 Ph: 562-304-2000	DATE	REV. #	PREPARED BY	SHEET NO.	TOTAL SHEETS
		7/24/18	1	JDC	1	2

EXHIBIT C2

PARCEL #	TITLE	AREA	APN
4-13, 14	TEMPORARY CONSTRUCTION EASEMENT	2,726 SF	4125-026-014, 015

LINE TABLE		
LINE	LENGTH	BEARING
L1	13.00'	S 89°49'05" E
L2	70.40'	N 0°09'57" E
L3	5.90'	N 0°09'57" E
L4	45.70'	S 42°30'46" E
L5	117.84'	S 89°49'05" E
L6	33.51'	N 89°49'05" W
L7	37.81'	N 42°30'46" W

CURVE TABLE			
LINE	RADIUS	DELTA	LENGTH
C1	889.00'	9°01'24"	140.01'
C2	468.35'	3°20'14"	27.28'
C3	885.00'	14°07'51"	218.27'

	Overland, Pacific, and Carter, Inc. 3750 Schauffele Ave. Suite 150 Long Beach, CA 90808 Ph. 562-304-2000	DATE	REV. #	PREPARED BY	SHEET NO.	TOTAL SHEETS
		7/24/18	1	JDC	2	2

Sec. 8. The City Clerk shall certify to the passage of this ordinance and have it published in accordance with Council policy, either in a daily newspaper circulated in the City of Los Angeles or by posting for ten days in three public places in the City of Los Angeles: one copy on the bulletin board located at the Main Street entrance to the Los Angeles City Hall; one copy on the bulletin board located at the Main Street entrance to the Los Angeles City Hall East; and one copy on the bulletin board located at the Temple Street entrance to the Los Angeles County Hall of Records.

Approved as to Form and Legality

MICHAEL N. FEUER, City Attorney

By  _____
CYNTHIA ALEXANDER
Deputy City Attorney

Date 8/21/18

File No. _____

m:\proprietary_occ\airport\cynthia alexander\eminent domain hutting ordinance - (final).docx

I hereby certify that the foregoing ordinance was passed by the Council of the City of Los Angeles, **by a vote of not less than two-thirds** of all its members.

CITY CLERK

MAYOR

Ordinance Passed _____

Approved _____