Compete4LA

Final Report to formally document the output of the Feasibility Study into the design, development and management of a program to open the supply chains of major sporting and infrastructure events to local, small and underserved businesses in the Greater LA Region. It describes the relevant challenges and sets out the characteristics of the optimal solution.

Presented to:



By:



Reporting Period: Dec 2017 – Aug 2018

Authors of Report: BiP Solutions and LABCI

Contents

Introduction.....	2
Feasibility Study Documents.....	4
Challenges.....	4
Recommendations	10
Characteristics of the Proposed Solution.....	12
Program Model – Compete4LA	13
Governance	22
Projected Costs.....	31
Acronyms and Definitions	32
Report Authors	33
Acknowledgements	34

INTRODUCTION

- In 2017, [LABCi](#) recognized that the 2028 Olympic and Paralympic Games could bring significant economic benefits to businesses in the Greater LA Region. While the 1984 Olympic and Paralympic Games were self funded, fiscally responsible, and even turned a small profit, they were not as successful for LA businesses, some of whom were even negatively impacted by the Games.
- Concious of this, LABCi reviewed past Olympic and other sporting events to discover their economic impact. This led to recognition of the success that BiP Solutions had with a supply chain program called CompeteFor in the London 2012 Olympic and Paralympic Games, and its continuing success more than 10 years after its launch. Since it's launch in 2007, over 200,000 businesses have registered on CompeteFor and more than 75% of the contracts on CompeteFor have been awarded to small and medium sized businesses ([SMEs](#)).
- LABCi then contracted BiP Solutions to execute a Feasibility Study, including desk-based research, stakeholder engagement, and the creation of a sample business plan based on BiP's experience in delivering CompeteFor and other supply chain services around the world.
- In reviewing what might be emulated to maximize the positive economic impact for LA businesses, it became apparent that the indirect business to business opportunities within the supply chains of the Olympic and Paralympic Games were the most tangible economic benefit.
- While this project's initial focus was the economic opportunity generated by the Olympics coming to LA, the greater opportunities, just as with London 2012, are the significant infrastructure and other major procurement programs being carried out by the City and County of Los Angeles, and the state. London 2012 itself was only the third largest civil engineering project in London's East End at the time of those Games.
- The 2028 Olympic Games will have a significant budget, but this will be relatively small when compared to the collective budgets of LA City, LA County, Metro Measure M, etc., as well as the many significant sports and entertainment events being held in LA. While all these procurement organizations require effective suppliers, they often want local, small, and underserved businesses to be able to compete for their fair share of these opportunities.

Unprecedented Opportunities	Value
Measure M	\$120 Billion
Measure HHH	\$1.2 Billion
Measure H	\$350 Million annually
Lucas Museum of Narrative Art	\$1 Billion
LAX Modernization Program	\$3,948 Million
2019-2022 Grammys	\$80-\$200 Million per annum
2022 Super Bowl	\$1 Billion
2023 College Football Playoff National Championship	\$270 Million

2023 US Open Golf Championship	\$100-\$240 Million
2026 World Cup	\$3-\$4 Billion
Demonstrable Needs	
97% of LA County businesses have <50 employees	
56% of firms in LA County are minority owned businesses (this represents 642,612 businesses)	
LA County has the 7 th Highest income inequality nationwide	
LA County has the 2 nd Largest homeless population nationwide	

Figure 1 Unprecedented Opportunities and Demonstrable Needs

- While BiP's experience of delivering a web-based supply chain solution was of interest, it became apparent that CompeteFor was not simply a software solution. CompeteFor's continued success is largely due to the integrated Buyer and Supplier Engagement Program, which underpins the software solution, ensuring users are able to derive the maximum benefit from the digital platform. CompeteFor remains a thriving hub of buyer and supplier activity more than a decade after its launch.
- Finding a way to open contracts to competition with as many small and underserved businesses as possible has the potential to deliver significant economic benefit, as opposed to the more traditional limiting of open competition to the prime contractor in the top tier of a supply chain.
- Despite the historically high levels of infrastructure spending in the Greater LA Region, there is a disparity between the proportion of small and underserved businesses in the Greater LA Region and the proportion of contracts they win from publicly funded work.
- While the two primary agencies (LA City and LA County) have not carried out a disparity study, there is evidence of disparity in the studies carried out by Metro.
 - For example, of the 12,149 prime contracts and subcontracts offered by Metro making up about \$3 billion of their budget, only 23.2% went to minority- or woman-owned businesses. Just 14.7% of the total contracting dollars went to businesses certified as Disadvantaged Business Enterprises.
- Following a thorough review of LA's procurement landscape, and testing the successful principles of London 2012's CompeteFor program with over 40 LA-based stakeholder groups, the team has identified substantial local support for the concept of a regionalized, web-based supply chain solution. This would be supported by an interoperability program and field-based engagement team to ensure that the maximum number of contract opportunities are made available to the maximum number of potential local, small, and underserved suppliers.
- This document will refer to the proposed program as Compete4LA (C4LA).

FEASIBILITY STUDY DOCUMENTS

The interviews, surveys, research, and analysis conducted as part of the feasibility study, to create a more objective understanding of the challenges and proposed solutions, have generated the following documents that are available upon request from LABCi.

1. C4LA - INCEPTION REPORT
2. C4LA - Prime Contractor Survey
3. C4LA - (Small) Business Survey
4. C4LA - Survey Findings
5. C4LA - Business Certification Overview
6. C4LA - OPTI Analysis of major procuring organizations in the LA Region
7. C4LA - OPTI Analysis of CompeteFor/London2012
8. C4LA - Stakeholder Analysis Matrix
9. C4LA - Procurement Legislation Overview
10. C4LA - External Presentation and CompeteFor Statistics Presentation
11. C4LA - PESTL Analysis of Procurement for Major Procuring Organizations in LA
12. C4LA - SWOT Analysis
13. C4LA - Procurement Portals
14. C4LA - Analysis of Costs (and associated commentary document)
15. C4LA - BUSINESS PLAN

CHALLENGES

The challenge of being a small and underserved business in the government procurement marketplace is a cross-cutting theme in markets around the world, where businesses often struggle to compete for and win business with public agencies. While there's no easy solution to this under-representation, we can identify where these challenges are similar and then can suggest proven, locally calibrated treatments to ameliorate them.

Problems include not only overly bureaucratic procurement systems and onerous qualification criteria, but also excessive risk aversion on the part of public buyers and a public sector marketplace operating in ways that pose challenges to many small firms.

Our local research identified a number of challenges faced by both buyers and suppliers in Los Angeles when looking to post or respond to contract opportunities. These were identified through surveys and interviews with local stakeholders, and through research.

The following table lists stakeholder groups, example organizations, and a summary of the challenges they face:

Public Agencies and Large Infrastructure Projects	e.g. LA City, LA County, Metro, LAWA
<p>Public Agencies and Large Infrastructure Projects need to ensure they are engaging with sufficient numbers of businesses to gain effective competition and to meet their inclusion targets for local, small, and underserved businesses.</p> <p>Recording and reporting on the characteristics of businesses within the supply chains of large procurement projects is often a challenging and manual process. A solution which automates this manual process and provides reporting based on it can show the current levels of business engagement, monitor changes in these, target interventions and support where it is most needed, and then monitor the progress of these supportive measures.</p> <p>Overall, work done during the Feasibility Study indicates that supply chain solutions at the Government to Business (G2B) level could be more transparent and consistent, and that there are no comprehensive supply chain solutions in place at the Business to Business (B2B) supply chain level.</p>	
Private Sector Projects and Prime Contractors	e.g. Lucas Museum of Narrative Art, Hathaway Dinwiddie, AEG
<p>Increasingly, private sector projects and prime contractors are expected to meet significant business inclusion targets set by public sector clients. This challenge is made more difficult when the private sector lacks:</p> <ul style="list-style-type: none"> • Existing supply chains containing sufficient numbers of small and underserved businesses to gain effective competition, and to meet any inclusion requirements set by funders; or, • A suitable place to post opportunities and gain effective competition; or, • An effective way to record supply chain activity to prove compliance or trigger further supply chain engagement. 	
Business Representative Groups and the Small and Underserved Businesses they Represent	e.g. GLAAACC, LA Gay and Lesbian Chamber
<p>Small and underserved businesses have difficulty in finding and responding to all relevant business opportunities from public agencies, infrastructure programs, and large sports and entertainment events:</p>	

- Lack of consistent advertising sufficient to open the market to competition, especially in relation to lower value and supply chain opportunities.
- Opportunities spread across multiple portals in the Greater LA Region. Our research showed approximately 30 different procurement portals and information systems for small and underserved businesses to navigate in order for them to bid for work. This list includes organizations which provide information about business certifications and/or certify businesses.
- Repeated requirements to provide the same basic information to register for multiple systems, e.g. business card information, business accounts, insurances, past experience, etc.
- The various certifications that can benefit small and underserved businesses through set aside contracts and preference programs are difficult to understand and utilize.
- The bureaucratic barriers facing small and underserved businesses in procurement processes can effectively rule out or discourage potential suppliers from bidding. Examples of these barriers are:
 - Time investment required to complete;
 - Disproportionately complex solicitations in relation to the subject matter and value of a contract;
 - Arbitrary requirements not related to the subject matter of a contract, e.g. disproportionately high insurance requirements.
- Often insufficient feedback following unsuccessful bids, which can cause potential suppliers to lose faith in the probity of the process. Insufficient feedback or lack of feedback makes it difficult for unsuccessful bidders to use a failed bid as a learning experience.

Business Support Organizations

e.g. SBA, Pacific Coast Regional

A number of business support organizations that exist to assist small and underserved businesses by providing training to explain the processes and procedures involved in procurement and to provide financing and insurance needed to submit compliant bids.

At present, local business support programs (such as those available from the Small Business Administration) are not being utilized to their full potential because of a lack of awareness among suppliers. There is currently no collective approach across LA’s public agencies and prime contractors to advertise these support services and direct suppliers and subcontractors to available resources.

Sports and Entertainment Events

e.g. 2020 MLB All Star Game, 2028 Games in Los Angeles

Although they are typically timebound, sports and entertainment events share many of the same challenges as other large procurement organizations and programs. In addition, they face one further issue, which is how to set up efficient and effective supply chains in a relatively short time. This task is often made even more difficult where these events are only able to provide short-term contracts and due to their brief existence.

Recording the demographics of the businesses within their supply chains is also challenging and is not effectively carried out by the major sports and entertainment events. Identifying a strategy to communicate the economic and community benefit of their event would be beneficial to most organizing entities.

While the above table provides the main groups of stakeholders, please refer to the “**C4LA Stakeholder Analysis Matrix**” for a full stakeholder list.

ORGANIZATIONS WHO OFFER CERTIFICATIONS	CERTIFICATIONS													
	FEDERAL			STATE OF CALIFORNIA							MISCELLANEOUS			
	SDVOSB	VOSB	WOSB	DVBE	SBE	ACDBE	DBE	MBE	SLB	WBE	EBE	LBE	LGBTBE	WBENC
Caltrans						✓	✓							
City of Los Angeles				✓	✓		✓	✓	✓	✓	✓	✓		
County of Los Angeles				✓					✓					
Department of General Services				✓	✓									
LA Metro					✓		✓							
Los Angeles World Airports				✓	✓	✓	✓	✓	✓	✓				
LA Unified School District					✓									
Southern California Minority Supplier Development Council								✓						
The Supplier Clearinghouse				✓				✓		✓			✓	
US Department of Veterans Affairs	✓	✓												
US Small Business Administration			✓											
WBEC West			✓											✓

Figure 2 – Organization which offer certifications

Please refer to the Acronyms and Definitions section on p.28 of this report for the long forms of the certifications in Figure 2 above. In addition, the separate “**C4LA Business Certification Overview**” explains the certifications and certifying bodies in Figure 2 above, and provides details on the following:

- Certifications available to businesses
- Certification requirements
- Benefits of each certification
- Costs of certification
- Recognition of the certifications by other organizations
- Available Business Support Programs
- Available Business Funding Programs

- Targets that some of the main public agencies have in place for DBEs

SUMMARY OF SURVEY RESULTS

BiP and LABCi conducted a set of Prime Contractor and Supplier Surveys to further understand the experiences of LA-based businesses when finding, bidding for and delivering contracts to public agencies in LA. A sampling of 10 Prime Contractors and 10 suppliers completed the survey. Results from the surveys support the findings from our initial research and stakeholder interviews, and our suggestion that a London 2012 inspired supply chain solution would benefit buyers and suppliers in the Greater LA Region, especially small and underserved businesses.

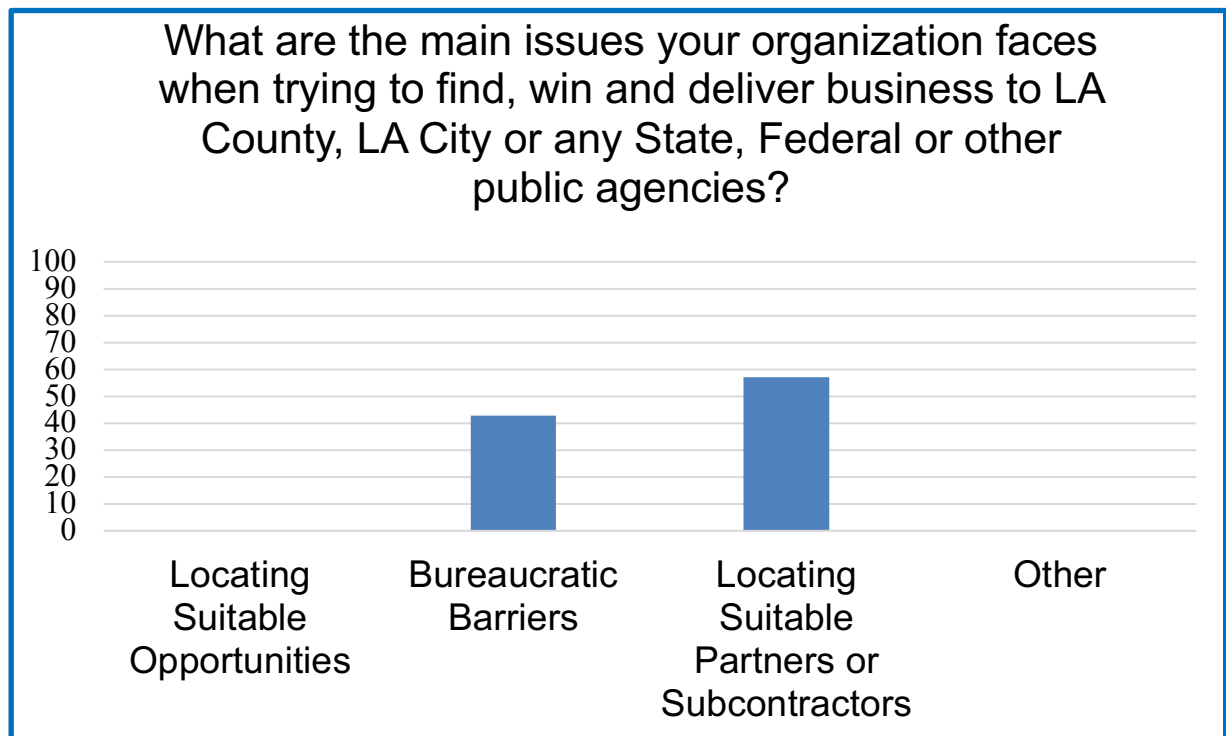

Figure 3 - Prime Contractor Question 9 Result

Prime Contractors identifying the difficulty of locating suitable partners or subcontractors as the greatest problem they face when trying to win public sector business supports the need for a comprehensive supplier database that allows suppliers to locate and collaborate with suitable partners, collectively respond to solicitations where unable to do so on their own, and to seek training and financing opportunities, etc. It is also worth noting that this problem is closely followed by the issue of bureaucratic barriers.

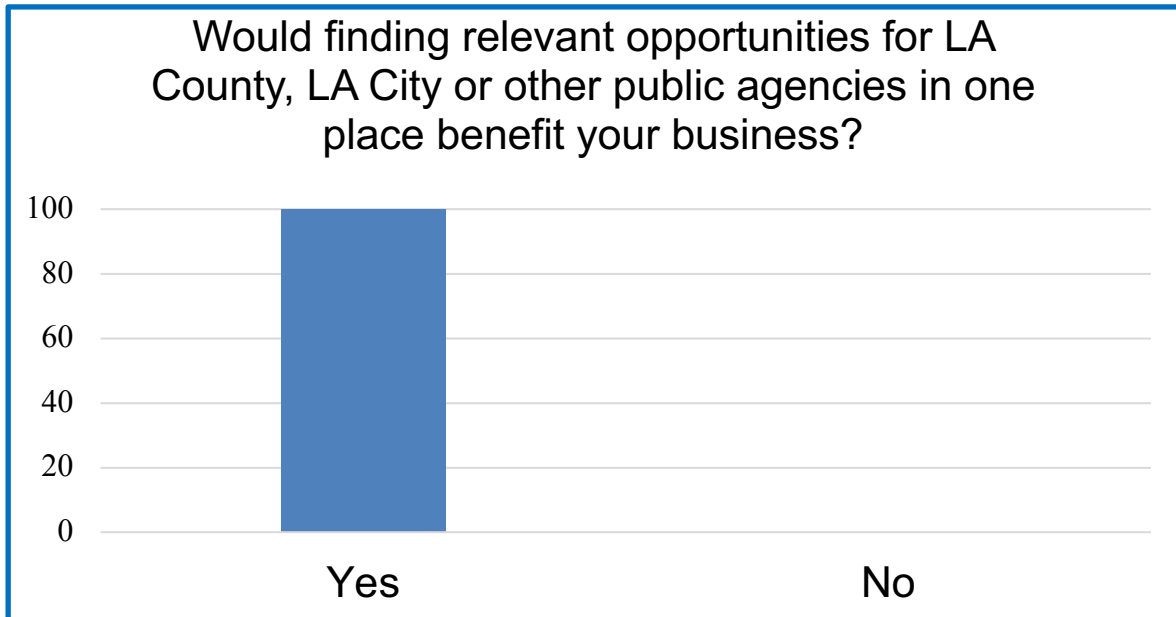

Figure 4 - Small Business Question 13 Result

The results for this question are both unanimous and support our key recommendations for an aggregated database of opportunities from procuring organizations in the Greater LA Region and their supply chains. This element of the proposed solution will mean that the effort to search through multiple databases will be greatly reduced.

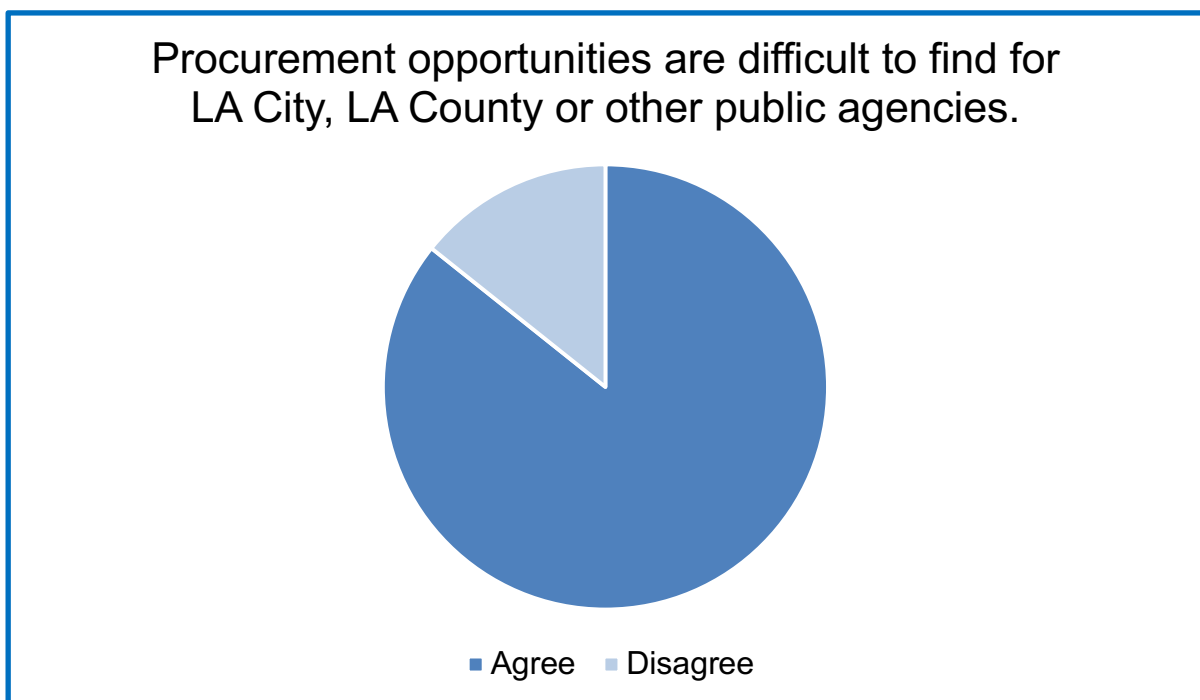

Figure 5 - Small Business Question 22 Result

Small and underserved businesses are often at a disadvantage compared to larger businesses that often have specialized resources to find and bid for opportunities. The output of this question, in the above figure, shows that small businesses are finding it difficult to locate opportunities issued by the public agencies in the Greater LA Region.

This is further evidenced below, showing that the majority of small businesses which completed the survey have no current contracts with public agencies in LA.

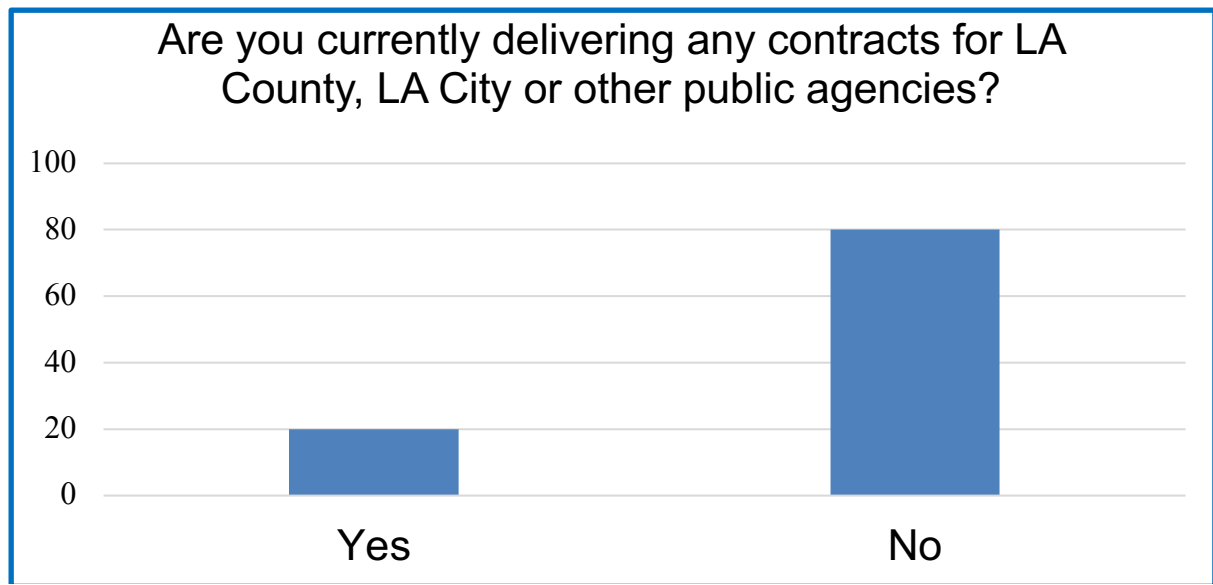

Figure 6 - Small Business Question 16 Result

Please note that there are further results available in C4LA – Prime Contractor Survey Findings and C4LA – Supplier Survey Findings documents

RECOMMENDATIONS

Based on the local research and stakeholder engagement, and drawing upon BiP's experience in delivering supply chain across the globe, we recommend the following as potential strategies to enhance procurement across the Greater LA Region:

- If the main agencies in the Greater LA Region (LA City and LA County) were to conduct a disparity study it would enhance the evidence provided thus far by Metro and should enable wider use of gender- and race-based certifications in the LA Region. Proposition 209 effectively removed the potential to use race and gender in set aside contracts and preference programs unless a disparity study has first been conducted objectively demonstrating the need for contracting policies in favor of minority and women-owned businesses. More specifically, a disparity study would detail the potential disparity in the proportion of women- or minority-owned businesses in the marketplace and the proportion of contracts they secure from public agencies.
- If disparity studies are carried out and disparity is evidenced, establish set aside contracts or preference programs for the benefit of small and underserved businesses.
- Commit to the simplification and homogenization of the pre-qualification process for potential suppliers, with the eventual aim of common standards across all regional agencies, thereby removing as much of the duplication of effort for small and underserved businesses as possible.
- Add contractual clauses to require the top tiers in large infrastructure and procurement programs to advertise their supply chain opportunities where appropriate. Add a flow down clause to ensure that this is repeated down through the supply chain.
- Ensure procurement policies and strategies are proportionately focused on small and underserved businesses, and that all staff responsible for procuring are adequately and appropriately trained.

SMALL AND UNDERSERVED BUSINESS TOOLKIT

As part of the project set-up phase, the delivery team should develop, issue, and deliver training on a small and underserved business toolkit to achieve the following:

- Advertise all sub-advertising threshold and low value/tail end spend.
- Make the lotting/unbundling of contracts a best practice for all large private procurement programs.
- Create a requirement for public agencies to divide large contracts into smaller lots – “comply or explain principle”.
- Make the consideration of set aside contracts/preference programs mandatory for all contracts above a certain value, and if procurers choose not to use them require them to explain this decision.
- Where set aside contracts or preference programs exist, ensure more rigorous enforcement of these inclusion goals and bidding/contractual requirements.
- Place supply chain transparency obligations in large contracts or procurement programs.

- Framework contracts should have modest or variable call-off volumes so that smaller businesses have a realistic chance of winning and delivering them.
- Buy labor and materials separately to create small contracts.
- Allow/encourage collaborative bids.
- Market testing of small and underserved business requirements.
- Ensure no artificial/arbitrary barriers to competition, such as disproportionately high insurance requirements.
- Permit supplier self-certification on lower value and risk contracts, and carry out due diligence on the preferred supplier prior to contract formation – but reserve the right to call for contract documentation at any stage.
- Do not exclude for minor documentary failings, especially where value and risk are low.
- Only ask questions that are relevant and proportionate to the subject matter of the contract.

This toolkit could be used by the Buyer Engagement Team to explain best practice support for small and underserved businesses, and could similarly be communicated to suppliers and business representative organizations to help suppliers understand what best practice looks like.

CHARACTERISTICS OF THE PROPOSED SOLUTION

Research, surveys, and more than 40 face-to-face meetings with LA-based stakeholders within this Feasibility Study have established the local demand for, and feasibility of, the creation of a supply chain program to serve the Greater LA Region and support the recommendations outlined above.

This should be a social enterprise that enhances the ability of local, small, and underserved businesses in the Greater LA Region to be able to find, win and deliver business to public agencies, large infrastructure projects and the private sector, especially the many significant sports and entertainment projects in LA.

Any surpluses generated should principally be reinvested for the benefit of local, small, and underserved businesses, rather than being driven by the need to maximize profit for shareholders and owners.

Vision – To be the Greater LA Region’s Supply Chain Portal for major procurement programs and capital infrastructure projects.

Mission – To deliver sustainable and measurable economic growth and community benefit by opening the supply chains of capital expenditure projects to competition, helping local, small and underserved businesses take advantage of these business to business opportunities to build their capacity and capability.

Building upon best practices of the CompeteFor program used to facilitate supply chain interactions during the London 2012 Olympic and Paralympic Games, this report proposes the creation of a **free to end user** Greater LA Region supply chain development program with the following characteristics:

- **All contract opportunities in one place** – Creation of a research, interoperability, and aggregation function for all contract opportunities across the Greater LA Region, both public and private.
- **A simplified and easy to use tool** for buying organizations to publish, shortlist, and award supply chain opportunities and low value (three quote) procurements.
- **A 'service wrapper'** – Creation of a support function which includes the 1st level (helpdesk) and 2nd level (tech support) for the user community, both buyers and suppliers.
- **A multichannel community engagement service** – The creation of a field-based outreach team which creates and drives supplier awareness, engagement, and embedding.
- **A trusted third party** – Create an ownership structure which is independent of (but complementary) to both government and the private sector and is based on a 'social enterprise' model.
- **Open access and interoperability** – Create a program of inclusion and partnership with other services/systems, both public and private, to drive more opportunities and more registrations.
- **Support and capacity building** – Identify suppliers in need of technical or financial support and refer to local programs (e.g. [SBA](#)) to build capability and capacity in the local supply chain.
- **[Open Contract Data Standard](#)** – Adopt the objectives of the OCDS programme and the data format standards.
- **Self-sustaining** – Develop the strategy and plan for a program that is free to users, but can be made self-sustaining through the development of a range of Value Added Services.
- **Business Certification Research and Development** – Execution of a research and mapping project which rationalises the data sets of business certification schemes; with the aim of educating suppliers as to what certifications they may be qualified for, what information they would need to apply for them, whether they have all of the required information and the benefits specific certifications would afford them if successful in becoming certified.

PROGRAM MODEL – COMPETE4LA

The proposed solution is intended to augment and reinforce existing regional procurement systems and programs for the benefit of small and underserved businesses. All proprietary stakeholders that have been engaged thus far have agreed that there is a need to help LA's local, small, and underserved businesses.

C4LA will promote efficient and effective procurement practices within the supply chains of major procurement programs and infrastructure projects in the Greater LA Region, assisting them in meeting their targets to work with local, small, and underserved businesses and providing objective evidence of this. This diagram shows the supply chain tiers referred to in this feasibility study, with tier one of the supply chain being the main contractor who supplies direct to the client. An organization that supplies tier one is a tier two supplier and so on.

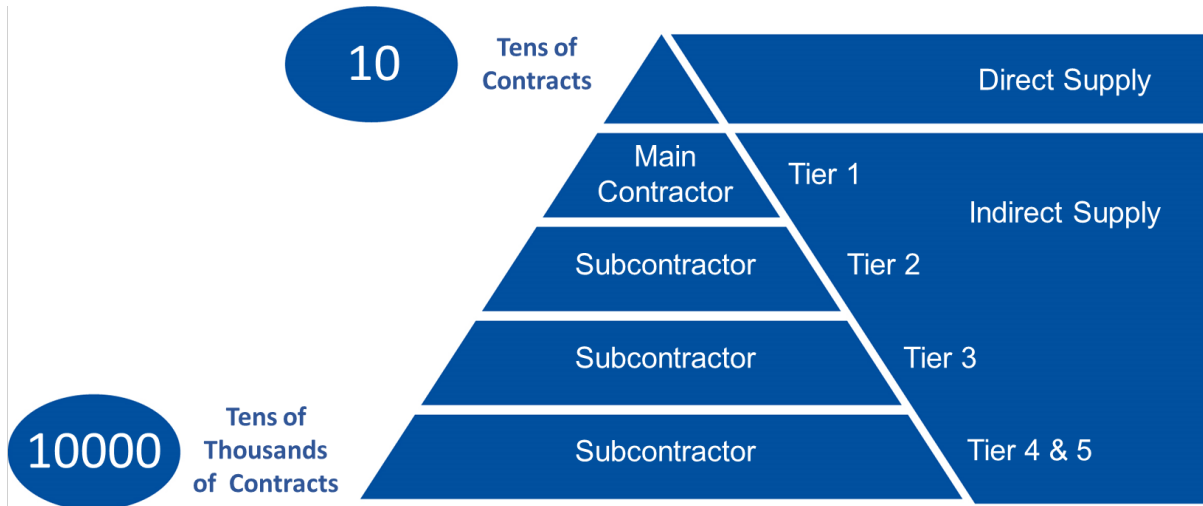

Figure 7 – Supply Chain Tiers

The core service includes the following free-to-user elements:

- The Portal
- Helpdesk Support
- Buyer and Supplier Engagement (BaSE) Team
- Interoperability Team
- Supplier Mapping and Reporting Functionality

THE PORTAL

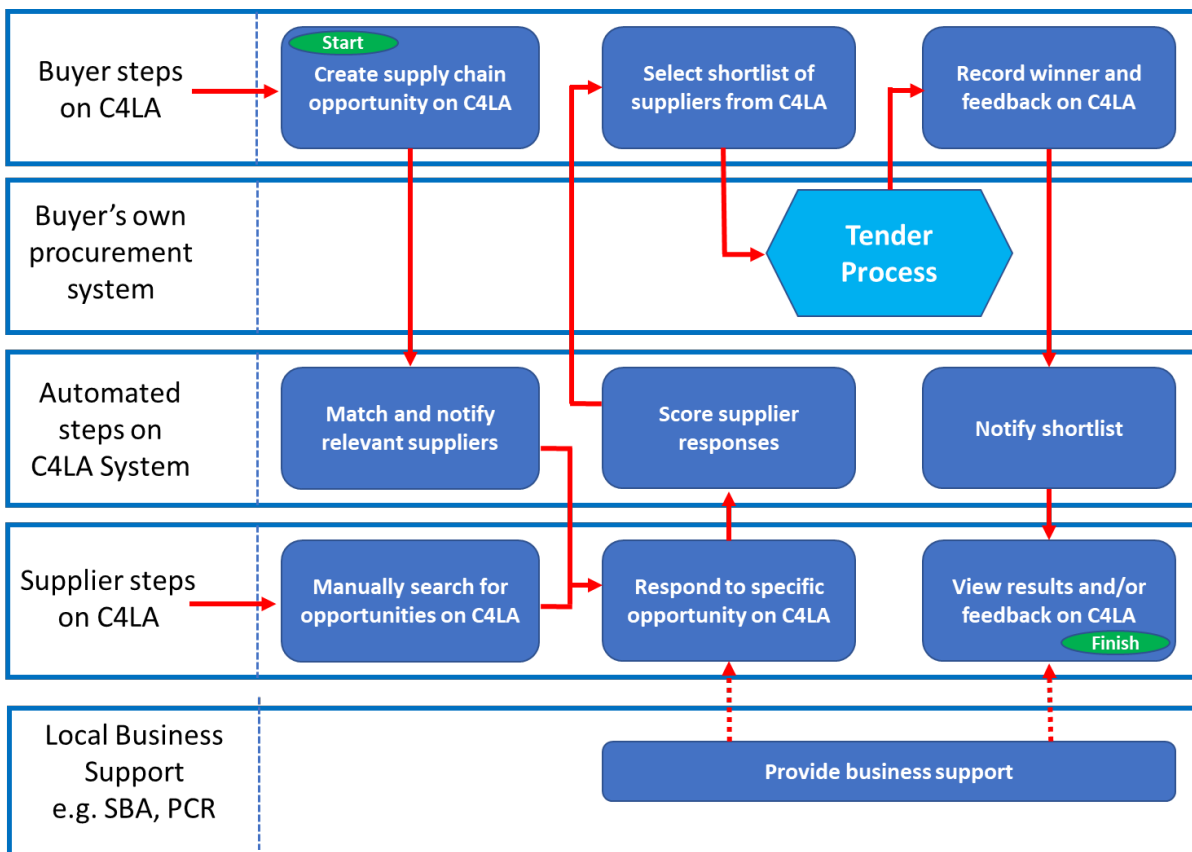

Figure 8 – C4LA Function Flowchart

BUYER BENEFITS

C4LA will be able to support the procurement needs of all types of purchasing organizations through the following opportunity methods:

Contract Opportunity – Create a pre-qualification questionnaire and shortlist potential suppliers. Once an opportunity is approved and published, an email alert will be sent to all suppliers in the specified geographic area with matching North American Industry Classification System ([NAICS](#)).

Notice Only – Post an advertisement directing potential suppliers to external eProcurement portals, for example, the Business Assistance Virtual Network ([BAVN](#)).

Request for Quote – Use C4LA as a supplier directory and request a quote from registered organizations.

SUPPLIER BENEFITS

C4LA will allow buyers to find qualifying suppliers for a shortlist prior to entering into their standard tendering process, which happens outside the portal.

C4LA will enable potential suppliers to respond to an opportunity by answering a simple questionnaire created by the buyer and in some cases providing a Supplier Statement. Answers to the questionnaire are scored automatically by C4LA using a scoring plan defined by the buyer.

After the response deadline, the buyer carries out a shortlisting process on C4LA using the automatically calculated scores and other information from each supplier's response.

If potential suppliers are successful in reaching the shortlist, the buyer will invite them to participate in their tendering process, which will usually involve submitting further details and documents outside of C4LA.

HELPDESK SUPPORT

The Helpdesk will log, manage, and resolve incidents relating to the services offered, act as a single point of contact for all first-level service fault reporting, and manage and record all enquiries regarding the C4LA.

The core service functions are as follows:

- A single point of contact for all logging, management, and resolution of enquiries and service fault reports
- Escalation of any problems to achieve satisfactory resolution

- A callback and progress reporting mechanism
- Audit trail of incidents, actions, and resolution times
- A mechanism to advise the client of any break in service
- A service that ensures that all suggestions for improvement are fed back into the development cycle of the service and its products
- A moderation service for content displayed on the site

BUYER AND SUPPLIER ENGAGEMENT (BASE) TEAM

Before describing the proposed approach to Buyer and Supplier Engagement, it is important to note that in many instances an organization can be both a buyer and supplier in the supply chain. The category “Buyer” or “Supplier” is merely a description of the organization’s behaviour at a point in time within the supply chain. We therefore look at these two groups and their supporting organizations, partners and stakeholders as one community with the collective aim of delivering positive economic benefits.

The approach to Buyer and Supplier Engagement is threefold:

- promote **awareness**
- facilitate **engagement**
- **embedding** the services to ensure optimum use of the service

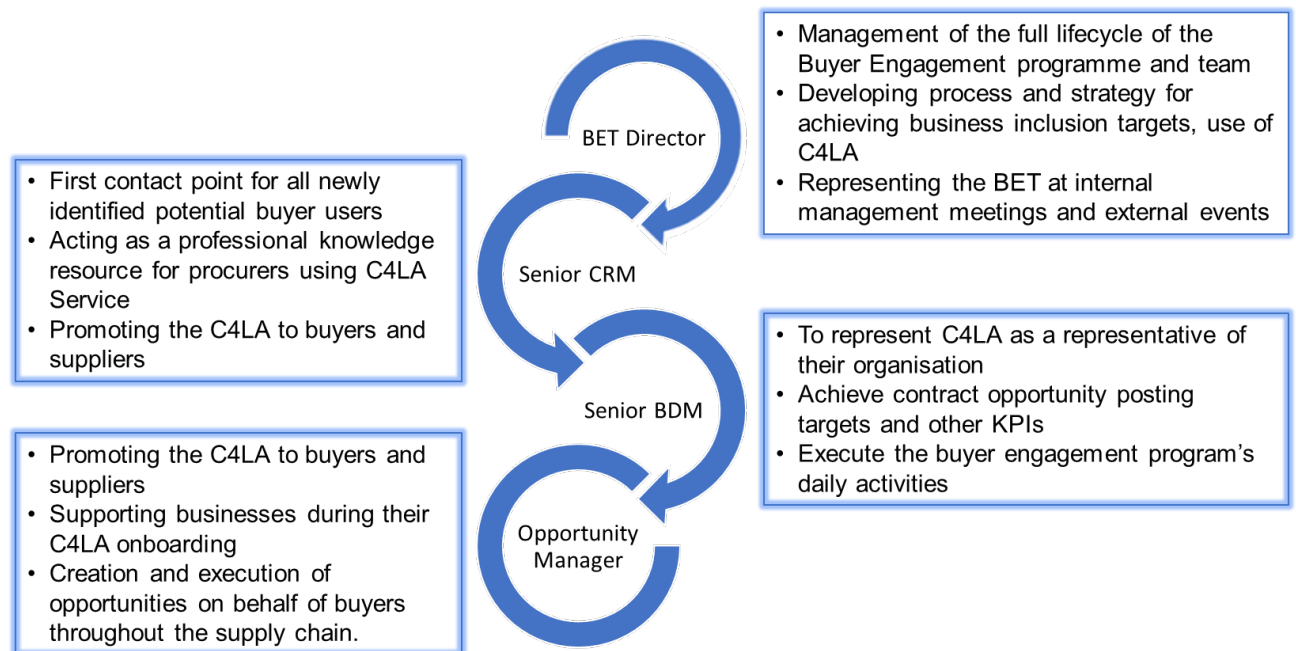

Figure 9 – Buyer Engagement Team Responsibilities

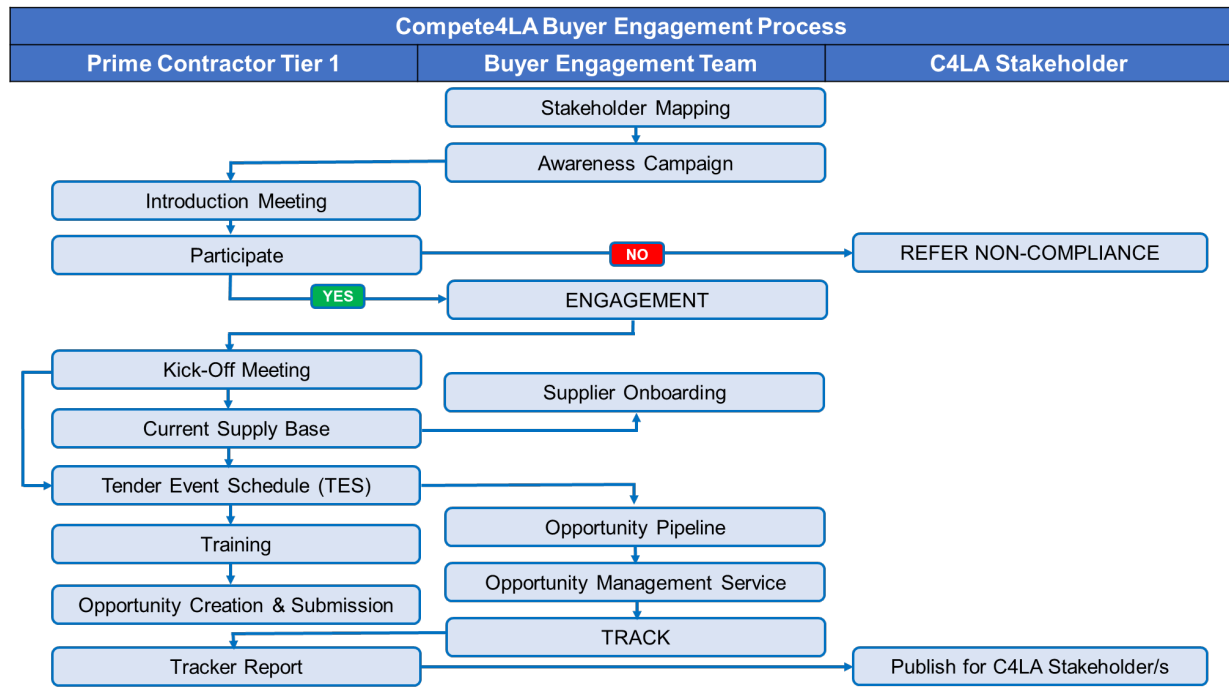

Figure 10 – C4LA Buyer Engagement Process

INTEROPERABILITY TEAM

The aim and purpose of the interoperability program is to ensure a large volume of contract opportunities flow through the system to be utilised by any registered users. It is envisioned that these opportunities will be secured through partnership and direct links between the C4LA system and other systems operating in the LA Region. To do this, the following activities and areas of focus will become the main responsibility of the interoperability team.

- Secure contract opportunity feeds from large procuring organizations
- Engage procuring organizations to capture tail end (low value) spend
- Reciprocal weblinks/logos to mutually drive web traffic
- Generate content for partner communications

Provide referrals to:

- External financing (SBA, PCR and other routes to finance)
- External training (SBA, UCLA, etc)

Utilize all potential partner communication channels, such as:

- SBA and Minority Chamber newsletters, events, etc.
- LA City, LA County, Metro, etc., information resources for suppliers
- Partner social media

SUPPLIER MAPPING AND REPORTING FUNCTIONALITY

The system will allow for the mapping of supply chains for major projects. Each project will be broken down into a number of opportunities to be posted on the Portal. As each opportunity is entered into the system, a Supply Chain ID will link it directly to the supplier awarded with the contract. Any opportunities posted by a supplier within the Portal that are directly linked to the project will be visible to the main organizer of the project, and potentially any organization sitting above the supplier in a higher tier.

A visual representation of this supply chain map can be found below.

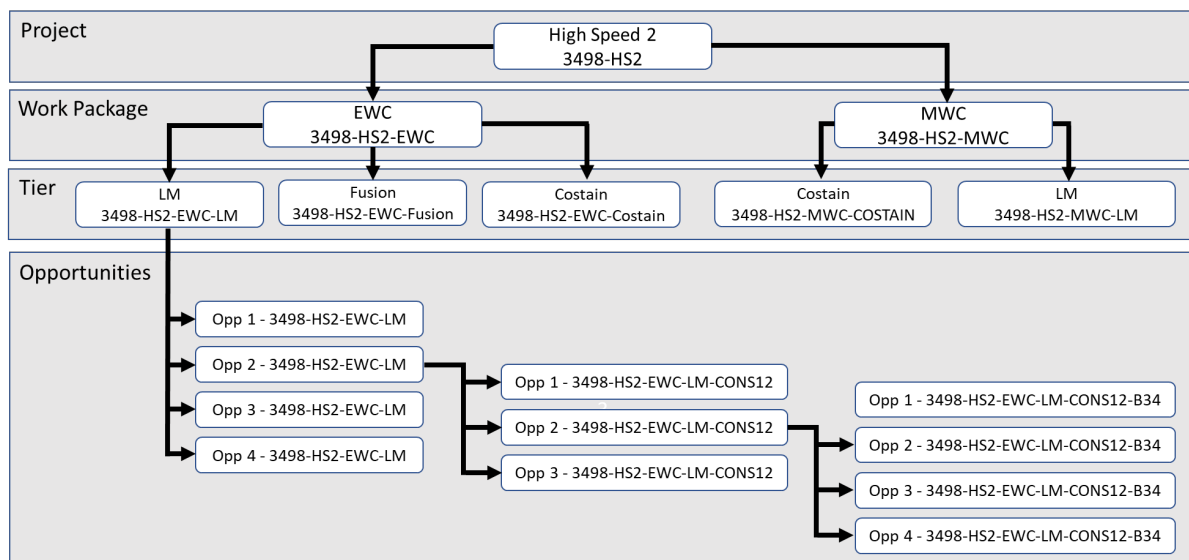

Figure 11 – C4LA Supplier Mapping Functionality

This following visualisation (of the UK's [HS2](#) project) shows the real-time flow of information through the supply chain tiers using project identification codes, so when a contract is awarded further down the supply chain it is reported in real time to the project owner, enabling decisions to be taken about real-time intervention.

Supply Chain Project Summary

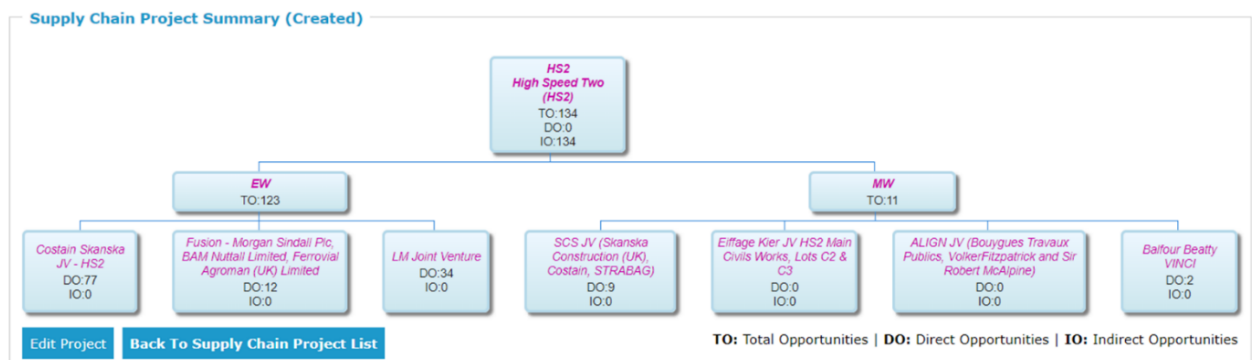

Figure 12 – C4LA Supply Chain Project Summary

The supply chain mapping feature above can be combined with system information to create powerful reporting functionality. This will identify, among other things, the:

- Number of opportunities sub-contracted
- Value of opportunities sub-contracted
- Value of opportunities delivered by individual suppliers
- Key users of the system.

While the list above is brief, reporting can be customised to give detail on any data field or combination of data fields.

SOLUTION IMPACT

As long as the key components of C4LA are funded, and no alternatives are established prior to C4LA's launch, we believe that the solution is in an excellent position to succeed in its objectives in the Greater LA Region.

Our research (***Please see the "C4LA Procurement Portals" for further information***) shows a complex ecosystem of procurement portals and systems, which C4LA would interoperate with to aggregate contract opportunities in one place and match buyers with suppliers from a large and diverse community.

This will be executed through the provision of a free to use web-based supply chain service with a special focus on local, small, and underserved businesses in the Greater LA Region.

The solution should augment existing procurement infrastructure, and is underpinned by the principles of transparency, competition, and non-discrimination.

Arguably the currency of economic development is the 'job', and C4LA will provide a free to use, level playing field to ensure local, small, and underserved businesses have the opportunity to find, win and deliver business that will fund new jobs and enhance existing ones.

C4LA will link businesses which require financial support, training, etc., to existing business support networks such as the SBA by providing real-time relevant information on the capability and capacity of local businesses as they bid for new business opportunities.

Businesses which do not possess the requisite capability and/or capacity to win and deliver opportunities themselves can form partnerships, consortia, joint ventures, etc to bid for opportunities otherwise beyond their reach. This will help make the joint venture between Kal Krishnan Consulting Services and Triunity Engineering and Management (both small, minority-owned businesses) which won a \$100 million contract with LA Metro a more common occurrence, rather than the one-off it currently appears.

While the benefits of finding opportunities on a single aggregated database are obvious, it is worth mentioning the significant, but less obvious, benefits that a completed business profile can offer local, small, and underserved businesses.

With time being an all too important commodity, the business profile at the core of C4LA will help businesses reduce the number of times they need to input similar information. This Write Once Read Many (WORM) approach will help prevent unnecessary duplication of effort, thereby making it more likely for these potential suppliers to respond to solicitations, partner with others, identify and successfully apply for certifications and find business support, training, finance, etc., as shown here:

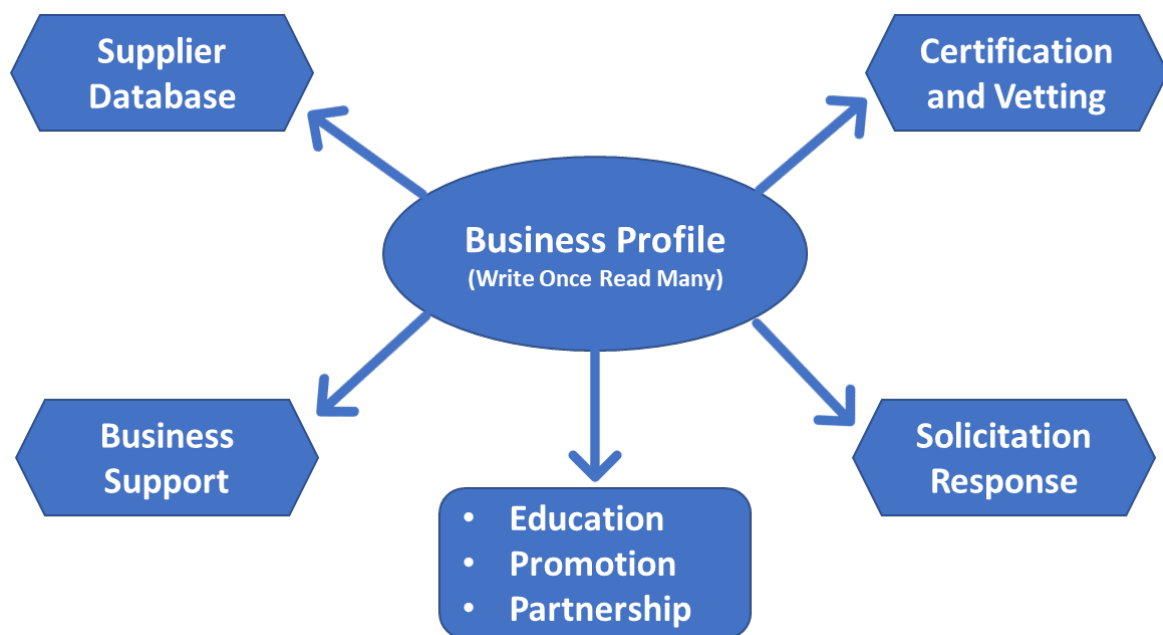

Figure 13 – Multiple uses of C4LA Business Profile

SOLUTION OUTCOMES

While more specific objectives will be developed once the funding and ownership of the solution is known, the desired outcomes of a fully funded solution are to:

1. Increase the number of small and underserved businesses actively competing for current direct and indirect supply chain opportunities in the Greater LA Region.
2. Measure the number of registrants on C4LA and their demographic breakdown.
3. Provide procurement organizations with the necessary tools, training, and helpdesk support to increase their ability to engage with local, small, and underserved businesses and enable them to meet their business inclusion goals with regards to them.

4. Create awareness within large infrastructure projects and sports and entertainment events, and engage their procurement teams to publish their opportunities on the service.
5. Open supply chain contracts below Tier 1 of major projects to competition by fulfilling Outcome 4 above, then conduct further buyer engagement and drill down through the supply chain tiers, thereby providing more opportunities for local, small, and underserved businesses in LA.
6. Create a wide and diverse database of suppliers to public agencies, large infrastructure projects, and sports and entertainment events so that buyers from these organizations have a better chance of being able not only to find potential suppliers for their preference programs or set aside contracts, but also to have sufficient numbers to open the market to effective competition.
7. Engage local, small and underserved businesses – Work with business representative groups, such as the minority chambers, SBA etc., to ensure that as many local, small and underserved businesses as possible register on, and benefit from the equality of opportunities it offers. Facilitate the development of LA businesses by promoting links to business support services.
8. Drive innovation and value – lower value opportunities on the portal will naturally attract a greater proportion of recently formed small businesses, which by their nature are more likely to be innovative as they try to exploit niches in marketplaces, as they often don't have the economies of scale to compete with large established providers. Naturally, as competition increases, businesses must improve the quality and cost of their offering, thereby enhancing the overall quality of businesses in LA.
9. Provide strategic and operational support for buying programs wishing to open up supply chains, and develop new supply chain relationships between prime contractors and subcontractors via enhanced supply chain visibility.
10. Build a business network to ensure a lasting legacy from LA's historically high levels of infrastructure spending, enabled by the training, advice and helpdesk support provided, to support job creation and retention.

A soft launch of C4LA will allow sufficient testing to be carried out, enable the BaSE Team to assemble, engage and train a coalition of willing procurement organizations, and arrange interoperability partnerships to:

- automate contract opportunity feeds
- establish reciprocal weblinks to drive web traffic
- coordinate mutual marketing and communication plans
- insert contractual clauses requiring use of C4LA in Tier 1-3 supplier contracts

Then the ongoing engagement of large infrastructure events and procurement programs can be ramped up for the hard launch, mobilising all resources and functionality.

This approach has the possibility to unlock the huge economic potential of the current historic levels of spend for the benefit of local, small, and underserved businesses in the Greater LA Region.

GOVERNANCE

TIERED GOVERNANCE AND OVERSIGHT STRUCTURE

C4LA will be a trusted, third-party entity, set up to manage, operate and run the service in the form of a joint powers authority, non-profit or social enterprise.

Internally, we envision a tiered governance and oversight structure comprised of the following:

- **Steering Group** (contains all key stakeholders): Oversee the project, provide advice, troubleshoot when necessary, and offer a stakeholder forum where issues can be addressed.
- **Governing Board**: Lead the organization by setting its direction and focusing on big-picture and future-oriented objectives, hold fiduciary responsibility, and act as a forum for regular reviews of contractual performance and the overall performance of the service.
- **Operations Group (Staff)**: Actively carry out the work required to deliver desired outcomes and provide users with a high level of service.

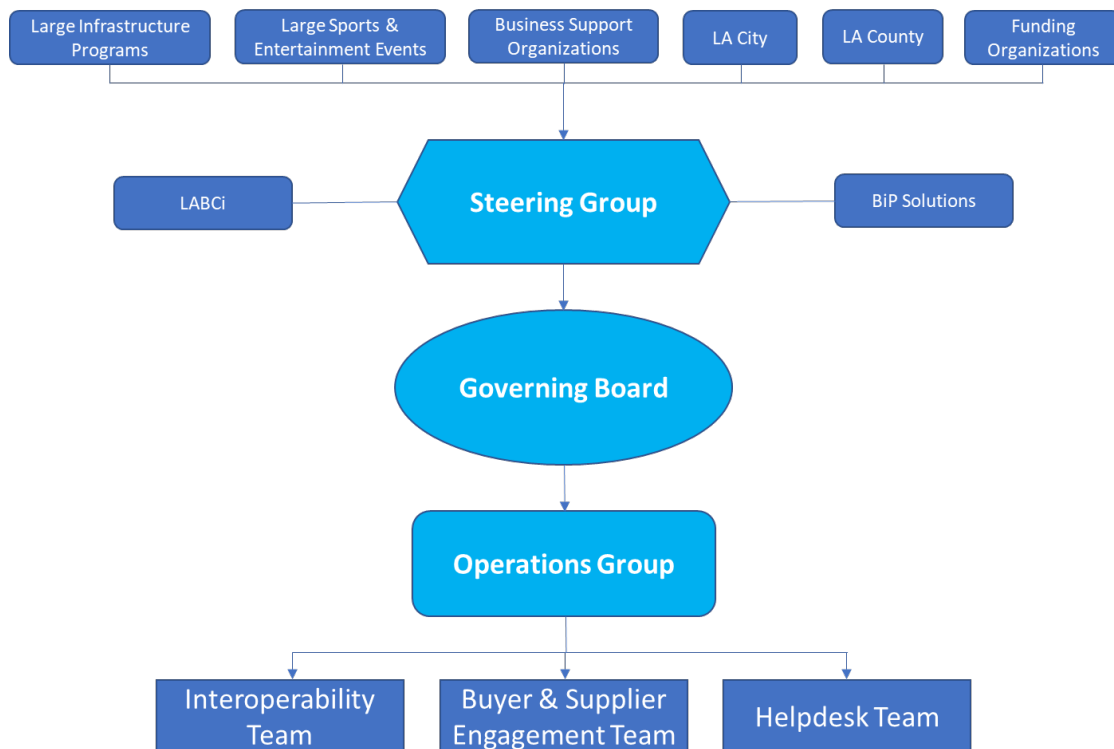

Figure 14 – C4LA High Level Organogram

DATA CONSIDERATIONS

While any data held by C4LA would have to be handled with care and in accordance with all relevant laws, it is worth noting the [CALIFORNIA CONSUMER PRIVACY ACT OF 2018](#) (CCPA) was just passed on 28 June 2018.

As passed (it could still be challenged), from 1 January 2020 the law would require businesses collecting information from California consumers to:

1. Disclose what personal information is collected about a consumer and the purposes for which that personal information is used;
2. Delete a consumer's personal information if requested to do so, unless it is necessary for the business to maintain that information for certain purposes;
3. Disclose what personal information is sold or shared for a business purpose, and to whom;
4. Stop selling a consumer's information if requested to do so (the "right to opt out"), unless the consumer is under 16 years of age, in which case the business is required to obtain affirmative authorization to sell the consumer's data (the "right to opt in"); and
5. Not discriminate against a consumer for exercising any of the aforementioned rights, including by denying goods or services, charging different prices, or providing a different level or quality of goods or services, subject to certain exceptions.

The CCPA also empowers the California Attorney General to adopt regulations to further the statute's purposes, and to solicit "broad public participation" before the law goes into effect. In addition, the law permits businesses to seek the opinion of the Attorney General for guidance on how to comply with its provisions.

As part of the proposed planning phase of this project, guidance should be sought from the Attorney General as soon as possible, so this can be factored into C4LA and applied from its launch as opposed to the go-live date of 1 January 2020.

The CCPA is directed at businesses that have \$25 million or more in annual revenue, or trade in the data of 50,000 or more persons or endpoints or derive 50% or more revenue from selling consumers' personal information.

It is highly unlikely that the CCPA will present a significant risk to the delivery of C4LA. However, this legislation and the guidance that is developed around it should be monitored throughout the development of C4LA. This law is not designed to arbitrarily restrict legitimate collection and processing of consumer data.

LEGAL STRUCTURE

The two main options for C4LA’s legal personality are either to set up a nonprofit 501(c)(3), or a Joint Powers Authority.

California statutes establish the types of organizations that may be formed. A charity or social enterprise may operate in California under any of several legal forms, including as a nonprofit corporation, trust, or unincorporated association. Yet regardless of the legal form chosen, this does not provide the organization with tax-exempt benefits. Obtaining tax-exempt status involves another process after the organization has been legally formed. Further information on charity formation can be found here:

https://oag.ca.gov/sites/all/files/agweb/pdfs/charities/publications/guide_for_charities.pdf

Figure 15 compares the social enterprise structure options for C4LA:

	Nonprofit	Social Enterprises	For-Profit
More Accountability	501(c)(3) Nonprofit Corporation	Benefit Corporation	Corporation with Third-Party Certification
More Flexibility	Nonprofit Corporation with For Profit Subsidiary	Social Purpose Corporation	LLC with Third-Party Certification
Most Flexibility	Unincorporated Nonprofit Organization (Not Tax Exempt)	Low Profit Limited Liability Company (L3C)	Unincorporated Business Association with Third-Party Certification (Sole Proprietorship General Partnership)

Figure 15 – Social Enterprise Structure Options
 (Table based on content created by the [Law Office of Jeremy Chen](#))

Figure 16 provides further information and the pros and cons for each of the above legal structures:

501(c)(3) Nonprofit Corporation	
INFO	<p>Being "501(c)(3)" means a nonprofit organization has been approved by the Internal Revenue Service as a tax-exempt, charitable organization.</p> <p>Nonprofit corporations must be established to accomplish one or more specific purposes that benefit either the public at large, a segment of the community or a particular membership. More specifically the 501(c)3 designation must have been formed for religious, charitable, scientific, literary, and/or educational purposes.</p> <p>A group must incorporate as a nonprofit in their state before they can obtain tax-exempt status under state and federal tax statutes.</p> <p>The team must meet specific requirements contained in state and federal tax statutes.</p>
PROS	<p>Exemptions from state and federal corporate income taxes.</p> <p>Can attract and receive public and private grant funds and donations (Tax-exempt government foundations and private foundations and charities are usually required to donate their funds only to 501(c)3 tax-exempt organization).</p> <p>Protection from personal liability.</p> <p>Separate and perpetual legal existence; i.e., a corporation is a legal entity that is separate from the people who work for it.</p> <p>Formal corporate documents, such as the articles of incorporation, bylaws and meeting minutes will outline the purpose of the group and provide structure to the organization.</p>
CONS	<p>Red tape and paperwork – Once the nonprofit corporation is set up and the necessary federal and state tax-exempt status has been obtained, tax and reporting returns must be filled with the state and IRS.</p> <p>Review Form 990 Return of Organization Exempt From Income Tax: http://www.irs.gov/uac/Form-990,-Return-of-Organization-Exempt-FromIncome-Tax-</p> <p>The corporation is accountable and requires the setting up and balancing of books and bank accounts.</p> <p>A board of directors must be appointed with regular meetings held.</p> <p>The corporation has restrictions on: paying directors and officers; dissolution; and political activities.</p>

	<p>The State Attorney General has oversight of the corporation.</p> <p>Be selective in how your board of directors is determined.</p> <p>Consideration of who will control the organization needs to be incorporated into the bylaws.</p>
--	---

Nonprofit Corporation with For Profit Subsidiary	
INFO	The Nonprofit Corporation can be adapted to allow profit to be generated to fund the nonprofit corporation.
PROS	This legal structure allows mission driven investors and the ability to receive donations while retaining its tax exempt status.
CONS	The downside of this is the duplication of effort taken for operational expenses as separation between nonprofit and the subsidiary is required. Otherwise, the tax exempt status could be revoked.

Unincorporated Nonprofit Organization (Not Tax Exempt)	
INFO	This is formed whenever at least two people agree to pursue a common lawful purpose that is not for profit. Usually best for people performing a community service or raising funds for a particular short term goal.
PROS	They can come and go as needed as there is no official incorporation.
CONS	Personal liability for any debts or court action. There is also the issue of it being difficult to enter contracts with other entities as there is a lot of risks on their part entering a contract with a legal entity such as this one.

Benefit Corporation	
INFO	This type of legal structure requires to state its benefit within the articles of incorporation. The share certificates must also state the benefit nature of the corporation.
PROS	Taxed the same as and offer the same limited liability protection as C corporations (corporations taxed separately from their owners). Designed specifically for social enterprises, with social goals being legally protected through mandating. It allows the ability for the project to make a profit.

CONS	There is expanded reporting requirements with this structure. This involves providing shareholders with the information proving the business is achieving its stated purpose. This type of legal structure is fairly new and there is the uncertainty of how they will be treated in the courts. A further effect of this is investors are more likely to avoid this type of corporation until there is more certainty surrounding it.
------	--

Social Purpose Corporation	
INFO	Along with the above, this is referred to as a hybrid corporate form that allows profitability and broader social and environmental objectives.
PROS	Designed specifically for social enterprises.
CONS	Since 2012 there have only been 9 of these. This shows that there are several other options out there being used instead of this one. Possibly with some of the same issues as above that because it is new it isn't quite trusted yet.

Low Profit Limited Liability Company (L3C)	
INFO	This legal form was created to bridge the gap between non profit and for profit investing by allowing investments in socially beneficial, for profit projects. This is established based upon the law of the state in which the company is formed.
PROS	Modified LLC designed to attract private philanthropic investments and program-related investments (PRI) by severely limiting the company's profit motives. Must operate in furtherance of a charitable purpose and prohibited from having a significant purpose to produce income.
CONS	Not available in California, but C4LA could take advantage of this form by forming as a L3C in another state that offers it.

Corporation with Third-Party Certification	
INFO	This involves the formation of a traditional C company and adapting it for social enterprise purposes. This is done by the company going through a third party assessment and certification of its business practices and mission-based objectives.
PROS	Third party assessment provides the social enterprise with measurable goals and the certification provides a measure of accountability to its stakeholders and customers.

CONS	Corporate governance issues may hinder the opposing factors of the for profit purposes and the mission based objectives. Certification is a voluntary process and does not require mission-based objectives to carry the same weight as others embedded within the company.
------	---

LLC with Third-Party Certification	
INFO	This is where an LLC is formed and adapted through third party certification.
PROS	This has great flexibility in management structure. Founders can draft an operating agreement, which is between the members of the LLC about how it will be run, to include accountability measures into the heart of the company. An LLC also gives the protection of limited liability and pass through tax treatment of profits, as profits are charged against members' personal income.
CONS	This legal structure struggles to engage with investors as there is less accountability and certainty on how the company will be run.

Unincorporated Business Association with Third-Party Certification (Sole Proprietorship, General Partnership)	
INFO	Best suited where the company is small and the owners share the same outlook on the objectives of the business.
PROS	These are very flexible legal structures as owners are free to operate without corporate restrictions. As above, profits are taxed on the personal income of the owner.
CONS	The main negative of this type of entity is the lack of limited liability – the owner will be liable for all debts of the company. Investors are also wary of this type of structure as it does not carry the same corporate structure as others previously mentioned. This structure is seen as a starting point only. As there is growth, the tendency is to head towards corporation.

Figure 16 – Social Enterprise Information, Pros and Cons

JOINT POWERS AUTHORITY (JPA)

A Joint Powers Authority occurs when public officials of two or more agencies agree to create another legal entity to work on a common problem, fund a project or act as a representative body. The Joint Exercise of Powers Act (Government Code §6500 et seq. gives the authority for governments to work together. The governance structure is flexible in terms of it is whatever the member organizations agree to. However, JPAs can only wield the powers upon which the founding organisations

already have authority to possess. The powers of the JPA must be outlined within the agreement from the outset, along with intentions of the JPA and mutually acceptable conditions that define the intergovernmental arrangement. The agreement must be filed as a Notice of a Joint Powers Agreement with the Secretary of State. Until this is done it cannot incur debts, liabilities, or obligations, or exercise any of its powers.

The reason this model was initially discounted was because it is only for public bodies. There is, however, special legislation which permits some non-governmental organizations to participate in JPAs. One instance of this was to help nonprofit hospitals keep pace with changes in the health care industry, JPAs were allowed to provide services in Contra Costa, Kings, San Diego, and Tulare counties.

JPA ADVANTAGES

- JPAs are flexible and easy to form. The Joint Exercise of Powers Act allows any government agency to participate in a JPA. The Act permits the member agencies to negotiate their levels of commitment and structure their own governing boards.
- JPAs may be more efficient than separate governments. JPAs allow local agencies to join forces and tackle issues together. The personnel, expertise, equipment, and property of each agency can be consolidated, promoting economy and efficiency.
- JPAs finance public works. JPAs can finance improvements such as parks, city halls, courthouses, and schools. JPAs can jointly purchase equipment, finance insurance pools, refinance member agencies' debts, and provide working capital by selling bonds.
- JPAs cooperate on regional solutions. JPAs serve as public forums for regional problems, providing residents with the opportunity to focus on regional issues. When the problems of affordable housing, transportation, energy, and drug trafficking cross local boundaries, JPAs can offer the wider view.
- Joint powers help communities find grants. Local agencies form JPAs to pursue grants to fund better services, start new programs, or purchase equipment. Participation in a JPA helps local authorities show the grant givers that they are willing to cooperate on regional problems - as opposed to competing with each other for grant funds for separate projects.

JPA DISADVANTAGES

- JPAs require mutual trust to form. Getting separate public agencies to cooperate can be hard because each organization has its own powers, purposes, and politics. Sometimes it takes a long time to build the trust that's needed before public officials are ready to sign a joint powers agreement that puts the common good ahead of individual needs.
- JPAs can be hard to keep together. Because a joint powers agreement is merely a voluntary relationship among the member agencies, local problems may threaten to split up the JPA. Changes in local public support, new political leaders, or financial pressures may cause a member agency to reconsider participating in the JPA. If a member agency pulls out, the departure may harm the JPA's long-term bonds or purchasing programs.
- JPAs can be hard to dissolve. To avoid the financial problems that can result if member agencies pull out of JPAs, some joint powers agreements include specific protocols that make it difficult to dissolve the agreements. To keep petty problems from splintering a long-term JPA, a dissident government may have to give the other member agencies months or years of warning before dropping out.
- JPAs can be hard to understand. Some people see JPAs as an additional and unnecessary layer of government, even when that may not be the case. Local residents may ask why they must call the JPA instead of a local office for answers to their questions. When agencies combine forces or create a separate agency to provide a service, the visibility, and accountability of the JPA may not be readily apparent.

LEGAL ENTITY ESTABLISHMENT

1. Determine the name of the corporation
2. Draft and file the articles of incorporation with the Secretary of State
3. Appoint the board of directors
4. Draft the bylaws and conflict of interest policy
5. Prepare and Execute an Action of Incorporator
5. Hold a first meeting of the Board of Directors and take the initial board actions
6. Obtain a Federal Employer Identification Number (EIN)
7. File the initial registration form with the California Attorney General's Registry of Charitable Trusts if applicable
8. File the Statement of Information with the California Secretary of State
9. Apply for federal tax exemption with the Internal Revenue Service (IRS) if applicable
10. Apply for California tax exemption with the California Franchise Tax Board (FTB)

Forms, Samples and Fees <http://www.sos.ca.gov/business-programs/business-entities/forms/>

POTENTIAL TAX-EXEMPT STATUS

There are several different kinds of tax-exempt designations permitted by the Internal Revenue Code. Most public benefit corporations apply for and hold tax-exempt status through Internal Revenue Code section 501(c)(3).

Having “section 501(c)(3) status” qualifies the organization to be both tax-exempt and to receive tax deductible donations.

Charitable public benefit corporations incorporated or operating in California also typically seek exemption from state income tax under California’s Revenue and Taxation Code section 23701, subdivision (d).

ONGOING LEGAL RESPONSIBILITIES

If a charitable organization operates or fundraises in other states, those states may have similar or additional reporting requirements.

FISCAL RESPONSIBILITY REQUIREMENTS

Charitable organizations, such as public benefit corporations in California, are required to maintain adequate and correct financial records and books. The board of directors should vigorously promote accurate fiscal management practices as officers, directors, and employees may be liable for “making, issuing, delivering, and publishing” any report, financial statement, balance sheet, or document “respecting the corporation or its... assets, earnings, liabilities, or accounts which is false in any material respect.”

GOVERNMENT REPORTING REQUIREMENTS

Charitable organizations have annual reporting obligations with various federal and state government agencies. For instance, even though nonprofit organizations do not pay taxes, they are required to file what are called “informational returns” with taxing authorities each year. State property tax and sales tax reporting obligations may also apply. Moreover, California nonprofit corporations file reports with the California Secretary of State to keep their corporate information current. Charitable organizations, including trustees, subject to the Attorney General’s supervision also must register and annually report to the Attorney General.

DIRECTOR AND OFFICER REQUIREMENTS

Every California nonprofit corporation must have a board of directors. Also known as board members, directors serve many important roles: they oversee the work of officers and other senior management, they make policy decisions for the charity,

and they ensure the organization is faithfully carrying out its charitable mission. The powers, duties, and limitations of what is expected and required from directors and officers are governed by California statutes and common law.

PROJECTED COSTS

These high-level projected costs provide estimates for the establishment of Compete4LA. A more detailed breakdown of the operating costs for the business model have been outlined in the C4LA Analysis of Costs document.

Phase Name	Description	Duration	Projected Costs	Planned Costs	Actual Costs	START	END
Start-Up							
Feasibility	Validate proven approach to local variables and desktop business plan	9 months	Complete			Dec-17	Aug-18
Planning	Design, detailed plan and fund	6 months	\$250,000			Aug-18	Jan-18
Set-up	Build, resource and launch	6 months	\$1,000,000			Feb-19	Jul-19
Operational							
Year 1	Business As Usual	Annual	\$1,000,000			Aug-19	Jul-20
Year 2	Business As Usual	Annual	\$1,000,000			Aug-20	Jul-21
Year 3	Business As Usual	Annual	\$1,000,000			Aug-21	Jul-22
Total			\$4,250,000			Dec 2017- Jul 2022	

Figure 17 – Projected Costs

FACTORS AFFECTING THE COSTING MODEL

- Ability to secure funding
- Determination of ownership and optimal legal identity of C4LA

NEXT STEPS – PLANNING PHASE

- Identify appropriate governance model
- Select a delivery team
- Secure funding
- Create detailed project plan
- Refine design based on Business Plan specification

NEXT STEPS – SET-UP

- Build C4LA demonstrator
- Resource core C4LA team and recruit partner organization/s for pilot
- Launch pilot

ACRONYMS AND DEFINITIONS

ACDBE – Airport Concession Disadvantaged Business Enterprise

BAVN – Los Angeles Business Assistance Virtual Network

BiP – BiP Solutions Ltd

B2B – Business to Business

C4LA – Compete4LA

DBE – Disadvantaged Business Enterprise

DVBE – Disabled Veteran Business Enterprise

EBE – Emerging Business Enterprise

G2B2B – Government to Business to Business

Greater Los Angeles Region (LA Region) – Encompassing five counties in southern California, extending from Ventura County in the west to San Bernardino County and Riverside County on the east, with Los Angeles County in the center and Orange County to the southeast.

LABCi – Los Angeles Business Council Institute

LBE – Locally Based Enterprise

LGBTBE – Lesbian, Gay, Bisexual, and/or Transgender owned Business Enterprise

MBE – Minority Business Enterprise

OPTI – Organization Process, Technology, Information

SBE – Small Business Enterprise

SDVOB – Service-Disabled Veteran-Owned Small Businesses

SLB – Small Local Business

TOR – Terms of Reference

Underserved Businesses – Businesses, such as those owned by minorities or women, that have been overlooked or excluded from equal access to information, resources, or economic opportunities. In consequence they have inadequate access to contract opportunities and, more specifically, the resources required to find, win and deliver them.

WBE – Women’s Business Enterprise

WBENC – Women’s Business Enterprise National Council

VOB – Veteran Owned Small Business

WOSB – Women Owned Small Business

REPORT AUTHORS

Philip Kinnell, BiP Solutions
 Scott Smith, BiP Solutions
 David Robertson, BiP Solutions
 Mary Leslie, LABC
 Devon Provo, LABCI
 Adam Lane, LABC
 Grady Schneider, LABC

ACKNOWLEDGEMENTS

BiP Solutions and the LABC Institute gratefully acknowledge the JPMorgan Chase Foundation for supporting this research.

We would also like to give special thanks to the LABC Institute Leadership Council for their continued guidance and contributions throughout this study.

Nadine Watt, Chair, LABC
 Watt Companies

Brad Cox, Chair, LABC Institute
 Trammell Crow Company

Arcelia Arce
 Office of Councilmember Nury Martinez

Georgette Bhathena
 JPMorgan Chase & Co.

Kevin Blackburn
 Federal Home Loan Bank

Richard Benbow
 University of California Los Angeles

Marsha Bonner
 Annenberg Foundation

Scott Bosarge
 AEG

Patricia Castellanos
 Office of Supervisor Shiela Kuehl

Mike Castillo
 Office of Councilmember Curren Price

Henry Cisneros
 CityView

Tricia Carey
 Port of Los Angeles

Cesar Diaz
 Office of Supervisor Hilda Solis

Kerry Doi
 PACE

Dorene Dominguez
 Vanir Development

Peter Gutierrez
 Latham & Watkins LLP

Bob Graziano
 LA Sports & Entertainment Commission

Gene Hale
 G & C Equipment Co

Anna Hovasapian
 Office of Councilmember Paul Krekorian

Michael Kelly
 LA Coalition for the Economy and Jobs

Sky Kelley
 Avisare

Ken Lombard
 MacFarlane Partners

Antonio Manning
 Affordable Living for the Aging

Mark Morales
 LA Gay and Lesbian Chamber of
 Commerce

Theodora Oyie
 Hathaway Dinwiddie

Victor Parker
 Small Business Administration

Manuel Pastor
 USC Center for Regional Equity

Sabra Purifoy
 LA County Department of Consumer
 and Business Affairs

Max Reyes
 Mayor's Office of Economic
 Development

Robert Sausedo
 Office of Supervisor Mark Ridley-
 Thomas

David Sears
 FivePoint, LLC

Breana Weaver
 Office of Councilmember Marqueece
 Harris-Dawson

Jon Vein
 LA Convention and Tourism

Andrew Westhall
 Office of Councilmember Herb Wesson

Jayne Wilson
 Office of Supervisor Janice Hahn

Kecia Washington
 LA Department of Water and Power

Richard Ziman
 Rexford Industrial